

Environmental Management

Lecture Notes

written by

Zoltán Szamosi, Baibhaw Kumar, Buta Singh

Initially blank

Contents

Chapter 1 Introduction to Renewable Energy.....	5
1.1 Energy Scenario of the world.....	5
1.2 Types of Energy sources:.....	6
1.3 Importance of Renewable Energy sources.....	8
1.4 A glance at the status of conventional energy sources	9
1.5 Energy Conversions.....	9
1.5.1 Indirect Energy conversion.....	9
1.5.2 Direct Energy Conversion	11
Chapter 2 Types of Renewable sources.....	13
2.1 Solar Energy and it's potential	13
2.2 The harnessing of wind energy.....	14
2.2.1 Advantages and Disadvantages of Utilization of Wind Energy.	17
2.2.2 Factors affecting wind distribution	18
2.3 Geothermal Energy.....	18
2.4 Classification of Geothermal Systems.....	19
2.4.1 Vapor based geothermal system.....	19
2.4.2 Liquid-based geothermal systems.....	20
2.5 Types of Electricity generation Geothermal Plants.....	21
2.6 Operational factors affecting the working of geothermal plants ...	21
2.7 Biomass as an energy source.....	22
2.8 Types of Biomass Extraction	23
2.8.1 Direct Extraction	23
2.8.2 Indirect Extraction.....	23
2.9 Advantages and Disadvantages of Biomass Energy sources.....	24
2.9.1 Major Advantages of Biomass Energy.....	24
2.9.2 Major Disadvantages of Biomass Energy	25
Chapter 3 Solar as a Future Energy source	25
3.1 The Sun and its Dynamics in Solar Energy	25
3.2 Useful terminologies on Solar Radiations.....	27
3.3 Solar Radiation Measuring devices	29
3.4 Useful geometrical Solar Angles.....	31

Chapter 4 Solar Photovoltaics.....	36
4.1 Why is Photovoltaics important?.....	36
4.2 Some limitations of Photovoltaics.....	37
4.3 Important Parameters of a Solar cell.....	38
4.4 Major components of Photovoltaic systems.....	40
4.5 Semiconductors in solar cells.....	40
4.6 Types of Semiconductors	40
4.7 Manufacturing of a Solar Cell	41
4.8 Some applications of Solar Photovoltaics	42
Chapter 5 Solar Thermal Collectors.....	42
5.1 Applications of solar thermal collectors.....	43
Chapter 6 Wind Energy	45
6.1 Windmill	45
6.2 Wind Turbine	45
6.3 Site selection parameters for wind turbines	47
6.4 Classification of wind turbines.....	49
6.5 Wind Energy Conversion principle.....	51
Chapter 7 Nuclear power.....	54
7.1 Reactor fuel	54
7.2 Components of a nuclear reactor	55
7.3 Types of nuclear reactors.....	57
7.4 Power rating of a nuclear power plant.....	58
7.5 Basics of nuclear safety	59
7.6 Nuclear Energy Economic Sustainability and Insurability	61
Chapter 8 Hydropower.....	63
8.1 Classification of hydropower plants.....	64
8.1.1 Run-of-River.....	64
8.1.2 Storage Hydropower	65
8.1.3 Pumped storage.....	66
8.1.4 In-stream technology using existing facilities	67
8.2 Efficiency	68
Chapter 9 Waste to energy.....	70
9.1 Technologies for conversion of biomass of energy.....	70
9.1.1 Incineration	70

9.1.2 Gasification	73
9.1.3 Pyrolysis	75
9.1.4 Types of pyrolysis	78
9.1.5 Anaerobic Digestion	81

Chapter 1 Introduction to Renewable Energy

1.1 Energy Scenario of the world

The word energy was coined by a combination of two Greek words, namely "en," meaning "within" and ergon meaning "work." These two words jointly frame the word "Energeia," which later in the 16th century becomes the today word "Energy." In the science world, the word energy means the capacity or ability to do any physical work. The flows of energy are the reason for any physical work possible in the regular world.

"The energy can transform its form, but the total energy of a given system always remains constant ~ First law of Thermodynamics."

SI unit of energy	<i>Joule or (N·m)</i>
SI Base units	$J = \text{Kg m}^2 \text{ s}^{-2}$
Other units of energy	<i>kW·h, BTU, calorie, eV</i>
Symbol for Energy	<i>E</i>

One Joule is equal to the work done by a force of one newton when its point of application moves one meter in the force's direction of action, equivalent to one 3600th of a watt-hour.

The 19th century was a century with many inventions and discoveries during the Industrial Revolution time. All these inventions were based on the use of energy in different forms. Today energy is the most important driving force behind any countries development.

In the year 2018, the global population 11 of 7.8 billion people compared to 4.3 billion people in 1978. The population explosion has been one of the major reasons for energy scarcity, which the world is facing today. The only viable solution to sustain this energy requirement history minimize population growth and try to find out the known and unknown renewable energy sources available on Earth. The global GDP has almost tripled in the last few decades, with an average annual

growth rate of 2.9%. To maintain or expand this growth rate, energy management technology must be advanced in harnessing the different forms of energy. The global primary energy consumption was recorded as 580 EJ in the year 2018, which leaves behind a huge carbon footprint on Earth. It has now become inevitable new energy technologies more pollution-free and less harmful to climate change. In the last 40 years, the global primary energy consumption demand was mostly covered up by fossil fuels. Until 2018, 25% of the global energy demand utilized energy, which was coal, gas, and oil. Thus, the development of more reliable energy Management and storage systems could play a crucial role in this new sustainability approach.[1]

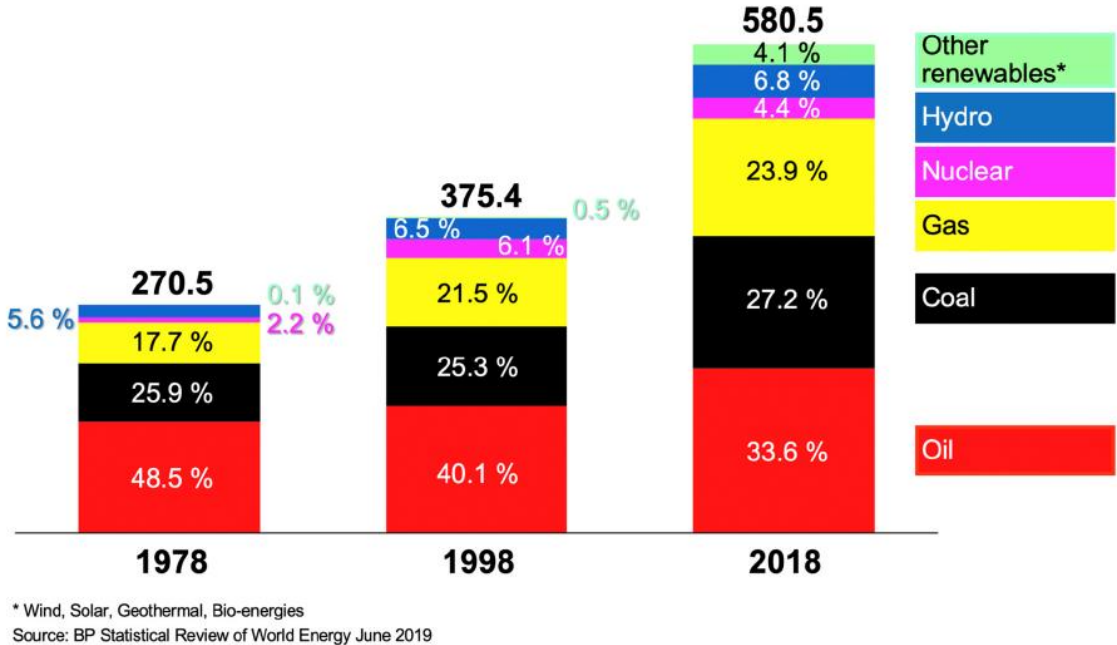

Figure 1. Global primary energy consumption 1978-2018 in (Exajoules)

1.2 Types of Energy sources:

- Primary Energy sources:** The type of energy sources directly derived from the natural naturally available resources on Earth are called Primary energy sources. For example, the solar, wind, hydrothermal, geothermal, and fossil fuels are some of the notable primary sources, which can be converted into the second form of energy known as a usable form. For these

kinds of sources, some energy is also spent in bringing it out from original sources for the user. This process is quantified by the Energy yield ratio.

$$\text{Energy Yield Ratio} = \frac{\text{Energy received from raw energy source}}{\text{Energy spent to obtain energy source}}$$

- **Secondary Energy sources:** All the resources, which are available in usable forms are called secondary Energy sources. For example, electricity, hydrogen energy, steam energy, etc. these energy sources that the most user-friendly and well accepted in various Industries and regular use of humankind. In these mentioned forms, electricity is the most commonly used form of energy.
- **Commercial and Non-Commercial Energy sources:** All the energy sources that are available on Earth freely and can be utilized easily without much technology, such as solar, wind, biomass Etc. are non-commercial energy sources. On the other hand, utilizing the same mentioned energy sources for electricity generation or any other industrial application are called commercial Energy sources.
- **Renewable and non-renewable energy sources:** The sources of energy available on Earth for a limited period of time and get exhausted eventually. For example, fossil fuels are called non-renewable energy sources. These sources take millions of years to form and are available on Earth in a limited quantity. Whereas the sources of energy which are freely available in unlimited quantity, for example, solar, wind, biomass, tidal, etc. called renewable sources of energy, these sources of energy are inexhaustible in nature.

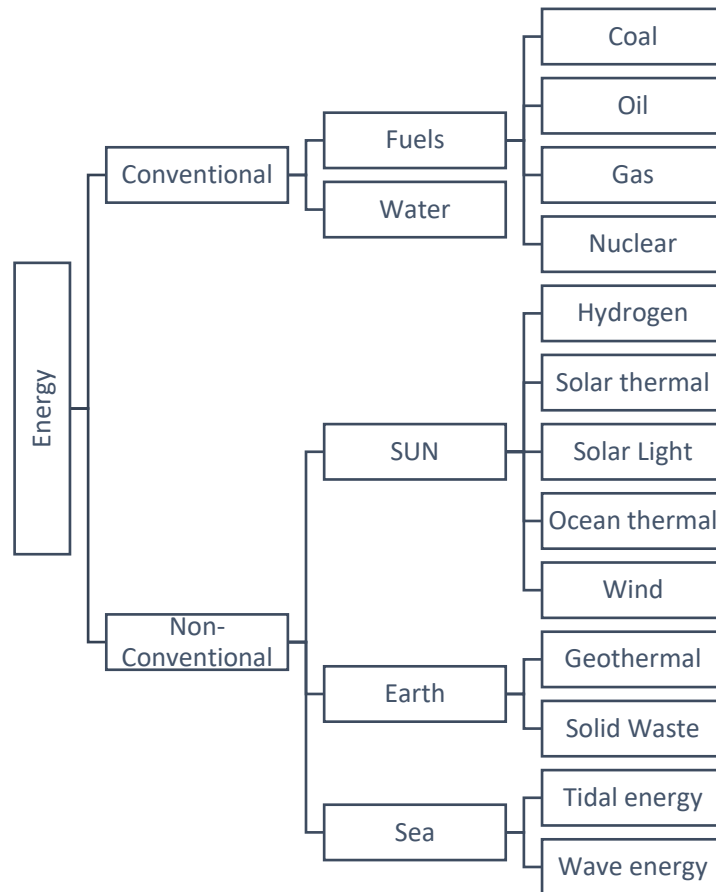

Figure.2. Classification of Energy sources[2]

1.3 Importance of Renewable Energy sources

As far as Primary energy resources are concerned, there is still a huge dependence on fossil fuels. This is an alarming situation in contrast with Global warming and climate change issues. The world is eagerly working towards renewable sources of energy for various power utilities. Renewable sources have thus become one of the most important fields of study in the scientific diaspora. Following are some mentioned points in this regard:

- The conventional sources are soon going to be exhausted in the coming decades.
- The world will face a massive energy crisis if renewable sources are not developed rapidly.
- The conventional sources are polluting the Earth at an alarming rate.

- The energy demand is on a constant rise and needs alternate solutions to cope with the growing demand and maintain environmental sustainability.

1.4 A glance at the status of conventional energy sources

In terms of cost, conventional energy sources are still cheaper than renewable energy sources. Storing conventional energy sources' capacity can be calculated easily, which provides a sense of energy security for a given time frame. The supply chain management of these sources has a universal outreach, and thus the transportation becomes feasible. Over the decade, the conventional sources have been established has a user-friendly apply to model. on the other hand, renewable sources yet need technological advancements to make them more user-friendly accessible cost-competitive. The non-conventional energy sources have to go a long way to compete with the existing available conventional sources.

1.5 Energy Conversions

The energy generated but from conventional and non-conventional sources needs to be converted to a usable form. To make it available for the end-user, it requires a fully developed supply chain grid. In the current scenario, the most user-friendly type of energy is electricity and will be so for the coming few decades. Hence, it becomes essential to convert the produced energy in the form of electricity for its proper use. The conversion principle can be broadly classified into two parts, namely Direct and indirect conversion systems that are described as follows:

1.5.1 Indirect Energy conversion

The conversion process in which the energy from heat form is transformed to mechanical and finally converted to electrical form are the Indirect conversion process. The chain of conversion can be seen in Figure.3. As below:



Figure 3. Indirect Energy conversion

Some of the indirect energy conversion systems are described as below:

Thermal-Electromechanical converters

These Converters are mainly used from coal, diesel, etc. to convert it into electricity. Various types of turbines I mostly the best example for Thermal-Electromechanical converters. The heat forces from the boilers are used to rotate the blades of the turbine, which in turn is connected to electrical conductors. The conductors create a magnetic field to produce the final form of electricity.

Binary stage Converters

The binary stage converters, as the name suggests, works on a two-stage process. In the first step, the low-grade heat form of energy is captured from the heat tank. It is then forwarded to a heat exchanger that enhances the present heat energy's capacity. In the next step, an enhanced heat form of energy is utilized to convert into electricity with turbines. This kind of energy conversion process is most suitable for natural solar and available geothermal resources.

Cogeneration Energy Converters

In an industrial setup, sometimes the energy can be generated by the co-utilization of steam and electricity with or without using the setup itself. Such an arrangement is called a Co-Generative energy conversion system. It works on the principle of topping cycle and bottoming cycle, which uses the excess heat in the system or as the waste recovery system. Both the Cycles work on utilizing the extra available heat somewhere in the system, which makes it an energy-conservative model. The cogeneration conversion mostly takes place in big power plants.

Hydroelectric Energy Converters

Hydroelectric converters are basically hydroelectric power plant which converts the potential energy is stored to moving kinetic energy for electricity generation. Kaplan, Francis, and Pelton are the three different hydroelectric turbines restart classified based on Height or Head. If g is the acceleration due to gravity, H is the Height, and Q is the flow rate of water with a velocity V then the power output P of the turbine can be given as follows:

$$P = \rho QgH \text{ kW} \quad (1)$$

1.5.2 Direct Energy Conversion

In the direct form of energy conversion, the source energy is directly converted into electricity. In this process, it is not required to use prime movers and mechanical turbines to generate electricity. The most common sources in such types of conversions are solar, chemical, thermal, and nuclear conversions. For example, photovoltaic cells' working could be a good example for direct energy conversion of the solar to electricity. The most common examples of direct energy conversions are listed below:

- Ion based Batteries
- Electrostatic generators
- Thermoelectric generators
- Thermionic
- Photovoltaic cells
- Piezoelectric generators
- Magneto-hydro-dynamic generators

C02 Emissions

The world today is suffering immensely from the greenhouse gas effect. One of the major contributors to pollution is due to carbon emissions. The global concerns on the increasing share of emissions and their impact on Earth led to the formation of the Kyoto protocol. The Kyoto protocol focussed on primarily six main gasses affecting severely to climate change. These were gasses, namely listed as Carbon dioxide CO_2 , methane CH_4 , nitrous oxide N_2O , hydrofluorocarbon HFC_s , perfluorocarbons PFC_s , and sulfur hexafluoride SF_6 .

Even among these mentioned gasses, carbon dioxide has the largest contribution to pollution. Most of the emissions related to carbon come from the urban production and manufacturing sectors. From raw materials, production, logistics to end consumer, the carbon footprints could be seen everywhere. Data shows that carbon dioxide emissions had increased from 22.15 % in 1990 to 36.14% in 2014.

Much of the emissions of CO_2 are anthropogenic (caused by humans) in nature. This gives a brief understanding of the surge in carbon accumulation in the past 100 years period. In recent years, pollution has been related to the air quality index measurement. Among several pollution forms, air pollution is most severely affecting humankind, mostly in the urban class population. However, carbon dioxide plays a significant contribution to the photosynthesis of plants. It helps them grow fast due to its presence. The emissions are very high than expectations, leading to a global temperature rise in the coming future. This could lead to the drastic change in flora and fauna present today on Earth.

Chapter 2 Types of Renewable sources

2.1 Solar Energy and it's potential

Almost all forms of energy directly or indirectly are dependent on the sun's behavior on Earth: the radiation, absorption, and transmission control solar energy production. After the oil crisis of 1970, the world started explorations to harness solar energy very rapidly. Today, solar energy shares a big share in power production through renewable energy sources. For the rural parts of many developing nations, small stand-alone systems have emerged as a boon. Solar Energy finds numerous applications not only in power production but in thermal and energy storage as well. The performance and utilization of solar-based energy generators depend on many parameters. Independent use of solar power requires a lot of analysis based on estimation models. These models work on the data of terrestrial inputs such as irradiance, altitude, clearance index, sunshine hours, etc.

Solar Energy is sustainable in its very sense. Its life span is considered to be 4-5 Billion years. Sun is a source of energy production and provides energy sources for other renewable sources such as wind, geothermal, ocean, tidal, etc. Along with long life comes the barrier of uncertainty for the potential harness. However, the sun's energy harness potential is more than other renewable sources such as wind energy.

The solar energy which reaches the Earth is 1.5×10^{18} KWh/year . Now, this available solar energy can broadly be harnessed in two prime ways.

By utilizing the radiation for heat storage and running thermal-based systems

By collecting solar radiation. And converting it directly to electrical form through photovoltaics.

With an extremely high temperature of 5800 K, several continuous reactions keep happening at the sun's core. These continuous fusion reactions continuously

produce immense energy. Among many others, the most important reaction is when four hydrogen atoms combine to form one helium atom. The mass of the nucleus of the helium atom formed is less than the four protons of hydrogen, which leads to fusion. The reaction is mentioned below:

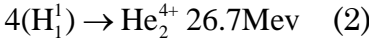

The earth-sun relationship needs to be understood to understand the various parameters of solar energy production. Being inclined at an angle of 23.5 Degree, the Earth completes a rotation on its own axis in 24 Hrs and completes the Earth's revolution in 365 days, which contributes to one year. Although the Earth receives enormous sun energy falling on it, almost 30% of that energy is reflected. This phenomenon of reflection is called the Earth's albedo. The angle subtended by the sun on Earth is 32' with an average distance of $1.495 \times 10^{11} \text{m}$. The figure below depicts the relationship between the Earth and the sun.

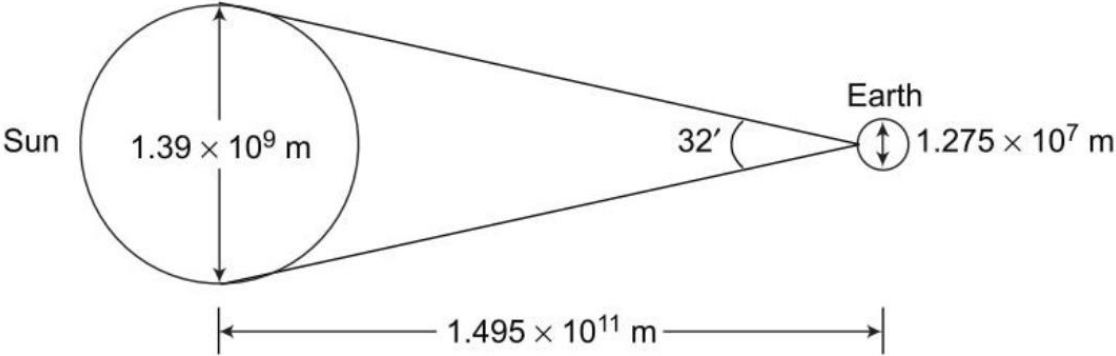

Figure.4 Earth-Sun relationship[3]

2.2 The harnessing of wind energy

The wind has been a source of energy for many long years. As early as 900 years ago, Europeans have been using wind for ship navigations to trade internationally.

In late 1800, the concept of the windmill was developed in North American regions for power production. The main transformation came after 1950 when it was started as a source particularly to produce electricity. In the years of 1970, the surge in commercial wind farms was evident due to state authorities' incentives to promote renewable sources. Though the major share of the energy comes from wind farms, many small stand-alone systems came into existence where the good natural flow of wind was observed.

Wind can be defined as the natural airflow in a horizontal direction across the Earth's surface. The wind is formed when there is a natural air pressure difference between two regions on Earth. The difference in air pressure is naturally caused due to solar radiation and its heating effect. Hence wind can also be considered as a byproduct of solar energy like many other energy sources. Wind energy can be classified into two types of local winds:

- I. Offshore and Onshore Winds
- II. Mountain Valley Breezes

Offshore and Onshore winds are a phenomenon that occurs mostly on the shore of large lakes or water bodies due to differential air pressure around the region. Such type of wind blows in the regions throughout the year. During the daytime, solar radiation heats the Earth's surface. Both the land and water bodies absorb the heat transfer from the sun. The water bodies warm up slowly as compared to the landmasses. The heat radiated back to the air warms up the air space creating air space above land lower than the air space above water bodies. Thus during the daytime, the air from water bodies moves towards land regions, and the movement is called Onshore winds. On the other hand, during night hours after sunset, the wind blows in the opposite direction, i.e., from land towards water bodies, and the movement is called offshore winds. The onshore and offshore breezes are depicted in Figure 5(a) and figure 5(b), respectively.

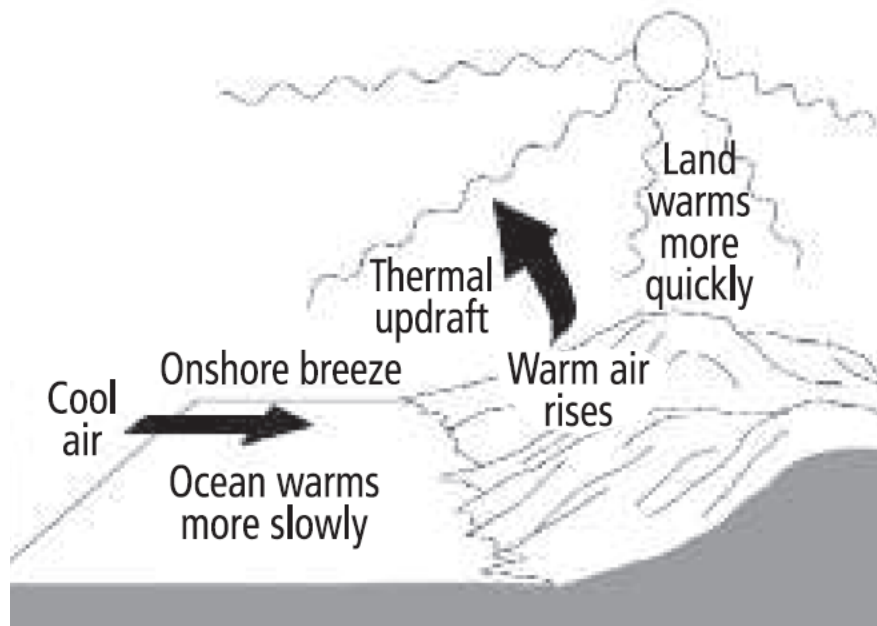

Figure 5(a) Onshore Wind Breeze

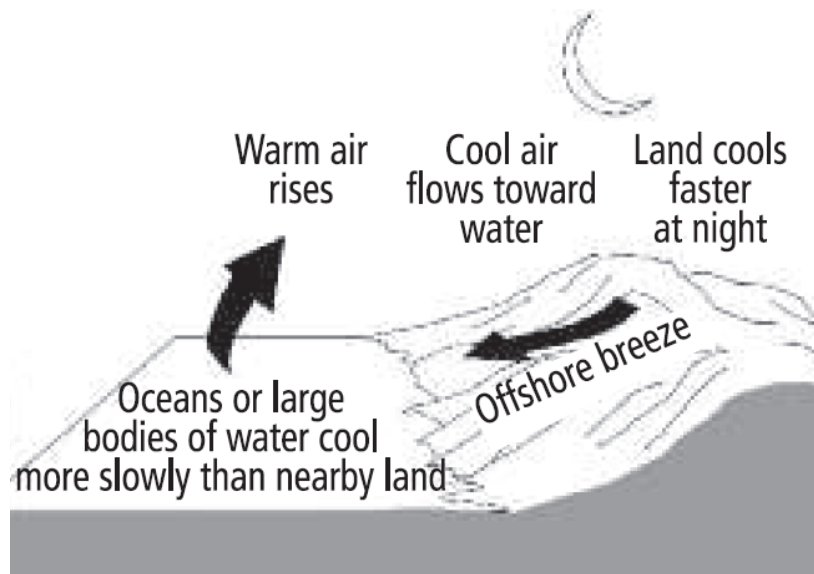

Figure 5(b) Offshore Wind Breeze[4]

Mountain Valley Breezes

Similar to the concept of shore-based wind movement, mountain regions also have their wind movements during day and night due to convection of heat from solar radiation, the difference in air pressure among the winds around walls of the mountain, and the valleys of mountain ranges. During the daytime, the wind blows upside from the valley towards mountains known as "Up valley" winds, and the airflow is reversed after the sunset and is known as "Down Valley" winds. Harnessing mountain valley winds is quite critical due to the inconsistency in the

flow patterns. In addition, the direction of wind flow plays an important role. The mountain breeze can more favorably be utilized mostly during the summertime. During summer, the weather in the mountains has calm weather compared to winters. Though the valley winds cannot be utilized as the prime source of power production, they could surely be useful as a backup support supply.

2.2.1 Advantages and Disadvantages of Utilization of Wind Energy

Advantages:

- Wind energy is considered a clean source because it leaves behind zero carbon footprints.
- Compared to fossil fuels, it's not limited to only a few countries but could be harnessed almost in every country to some extent.
- Among the other renewable energy sources, wind is among the cost-effective energy source.
- Wind farms could be the best solution to make use of barren lands. Also, it can be clubbed with big agricultural farms to make optimal use of the farmland.

Disadvantages:

- Wind, when compared to fossil fuels, still lags. The power efficiency and cost-effectiveness of wind farms are quite high in comparison to conventional sources. The huge investment demands for setting up finance make it not too feasible in regular use.
- Storing the energy for a regular power supply is inevitable in the modern world. The wind almost fails to provide a regular power supply if the wind flow is intermittent in nature.
- Grid connecting possibilities becomes difficult for wind energy if the farm locations are too far from the urban population of cities.
- Wind farms still need a lot of improvement by technology and engineering solutions to make it a cost-effective renewable energy solution.

2.2.2 Factors affecting wind distribution

- The site selection for a windmill or windfarm setup is affected by several factors. Some factors are global influence, and some have local conditioning. These parameters play a constructive role in the development of a wind energy-producing setup.
- The mountain ranges all over the world have an impact on the wind direction and its flow over a region in a broader sense. Sometimes the mountains are defining the weather conditions of the concerned place.
- Seashores are more suitable for wind farms due to less friction coefficient. The trees, hills, cities, etc., work as a roughness gradient for wind flow. Thus the lesser the friction better the wind flow profile could be achieved.
- Fluctuating climatic conditions such as heavy rainfall and thunderstorms restrict the smooth flow of wind as well.
- Mountain valleys could be a good place to channelize the wind flow for energy generation.

2.3 Geothermal Energy

The Earth holds a huge resource of energy in the form of heat under its belt. The proportion of this potentially inexhaustible source is unlimited. However, the extraction of this resource is minimal due to a lack of technological advancements. Volcanoes, hot springs, boiling water pots, etc., are some examples of "Geothermal Fields." Any geographical location which is 10Km deep and has a temperature greater than 15 is considered a "Geothermal resource". The lack of economic feasibility and technology makes it a low-grade form of energy. The spatial analysis could play an important role in understanding the site selection process for geothermal sources. The shallow sites or sources are explored using a vertical closed-loop ground heat source pump.[5] This has been proven one of the most reliable and technology in conditioning heating technology. According to US Energy Information Agency, the amount of electricity generation utilizing geothermal was estimated to be 86 Billion KWh worldwide.[6]

Like any other source of energy, geothermal energy also has some advantages and disadvantages as per their use. Some of them are mentioned as below:

Advantages

- It is a continuous source of energy that can be harnessed continuously without interruption.
- It is independent of intermittent weather conditions.
- The Earth acts as a natural reservoir for the resource so no extra storage facility is required.
- The plant set up for geothermal sites requires very limited land area.
- It is a comparatively cheap and economically feasible energy source.

Disadvantages

- The energy harnessed is a low-grade form of energy.
- The exploitation of geothermal is site-specific hence cannot be set up anywhere.
- Sometimes during extraction, it also releases unwanted and toxic gases, which are present below the Earth naturally.
- The energy acquired could not be transported to the long-range area. It's mostly restricted to a range of 30 km.
- Long-time continuous extraction may lead to slumping of the soil or earth surface in the region.

2.4 Classification of Geothermal Systems

2.4.1 Vapor based geothermal system

The vapor systems are also known as dry steam systems for energy extraction. This system is less popular than other geothermal extraction systems. This system is more favorable in places where ground permeability is comparatively less. This system's working principle works on upward channelizing of the vaporization process below the Earth and making use of the energy.

2.4.2 Liquid-based geothermal systems

This is the most common geothermal-based system. This setup makes use of the natural hot water springs to harness energy. The heat potential is shallow and mostly cannot produce Power. However, the low-grade heat is directly clubbed for the utilization of heat applications.

Analysis of Energy Extraction from Geothermal sources

Understanding the heat extraction below mentioned figure could be helpful. In the figure below the heat, calculation could be performed for hot dry rock case.

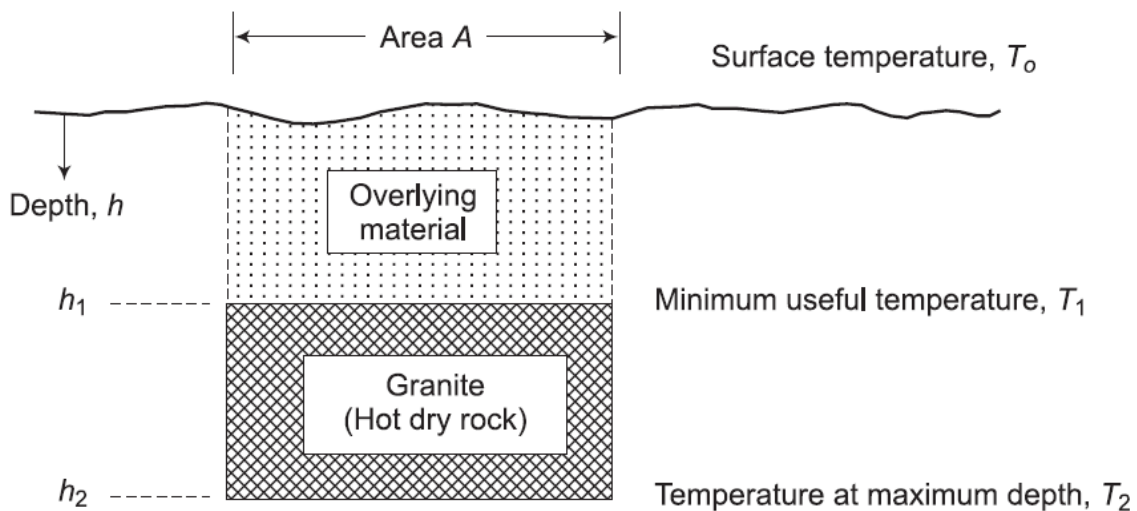

Figure 6. Profiling of hot rock system for heat calculations[3]

Due to the fact that there is no convection temperature T , will grow linearly with the depth of the bed.

$$T = T_o + \frac{dT}{dh}h = T_o + Gh \quad (3)$$

Where, G is temperature Gradient

T_o Is surface temperature

h is the depth

$$T_2 - T_1 = G(h_2 - h_1) \quad (4)$$

The average useful temperature θ_0 of the dry rock is given by,

$$\theta_0 = \frac{T_2 - T_1}{2} = \frac{G(h_2 - h_1)}{2} \quad (5)$$

2.5 Types of Electricity generation Geothermal Plants

- Flashed Steam-based Plants: The boiling water known as "flash" is used to rotate the turbine setup for electricity generation.
- Dry steam Plant: The natural steam coming from the deep earth surface is utilized to create electricity.
- Binary source Plants: In Binary plants, the hot water is used to heat a secondary liquid which vaporizes, and that vapor is used for turbine rotation to generate electricity.
- Hybrid Plants: When the flash-based plants are combined with binary source plants such operating plants are known as Hybrid Plants.

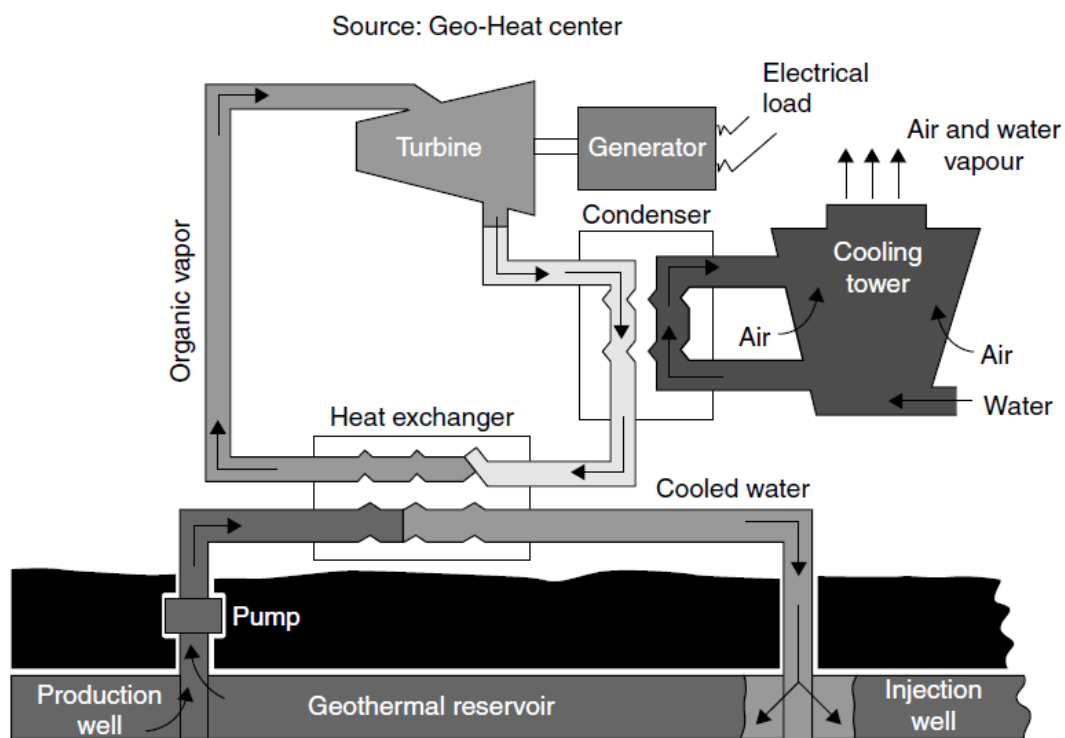

Figure 7. Binary Geothermal electric power plant setup[2]

2.6 Operational factors affecting the working of geothermal plants

- Compared to fuel-fired boiler plants, geothermal plants are much easier to operate due to lesser boiler complexities.
- The workforce requirement for these plants is minimal. The round-the-clock operation could be performed in these plants without much mess.

- As the plant is self-operational, it requires technical innovations to control the monitoring of the operations. Sometimes alarm systems are inbuilt with the set up to control the temperatures and monitor the performance of the plant.
- The valve functionalities should be monitored frequently. Daily basis cross-checks required for smooth functioning. Any presence of impurities in the steam produced could be a possible threat to the operating system.
- Personal protection equipment is required by the operators to withstand the noise of the steam ejectors. These ejectors while operation creates very high noise which is unbearable to human ears.
- The estimation of power production is still a major problem for geothermal plants due unavailability of exact data for the reserves.
- Separation of steam from the steam-water mixture is very critical during operation. It should be thoroughly ensured that only the separated steam moves through the production system's movement pipelines.
- The economic feasibility of the plant should be at par with the production output of the plant facility. If the plant fails to achieve feasibility, the production costs go high, and the setup will not sustain in the longer run.

2.7 Biomass as an energy source

Anything which comes under the organic matrix could be termed biomass. The wide umbrella comprises many vivid kinds of organic materials such as plants, bacteria, wood, bush, crops, etc., and their after-process residual wastes. Biomass could be an indirect form of solar Energy on Earth. The process of photosynthesis converts the organic material to store the energy in them which could be utilized later to produce energy. The organic material when undergoes photosynthesis sugar as shown below in the equation.

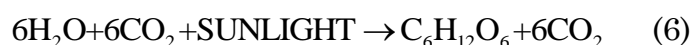

The interesting part about biomass is that the consumption and release of carbon dioxide emissions are almost equal during its production and later its combustion. Thus, leaving behind almost negligible carbon footprints on nature. This concept

gives the name "Bio-Fuel" and any organic matter today is considered as a potential Bio-Fuel. One of the facts, which distinguish biomass from other renewable energy sources, is that in this case, the availability and its production can be controlled as desired. The biomass can only be utilized when biomass is converted to intermediate form from its existing natural form, such as methane, ethanol, charcoal, etc. This conversion could be done both by chemical and biological conversion processes. The development of biomass extraction as renewable energy should be at a natural pace and not at an industrial pace. If forests are cut down to produce biofuels, it will have a reverse impact on the ecology. Today's fossil fuels' origin lies in the biomass, which was present millions of years ago. The use of biomass for energy production in developed countries is around 3%, but it is still a prime energy source in many developing nations. There are broadly two ways of extraction of biomass energy, mainly Direct methods, and Indirect methods.

2.8 Types of Biomass Extraction

2.8.1 Direct Extraction

For the direct extraction of biomass, simple raw materials are required. These raw materials are nothing but the organic compounds naturally occurring. The material could be available in forest waste, agricultural crop residuals, industrial wastes, human and animal wastes, etc. The management of all these forms' residuals could provide a good chunk for biomass for energy generation.

As these materials are naturally available in raw form, their energy density is found to be low. The presence of moisture content degrades the burning capacity of such materials. The most common and age-old utilization of direct extraction is using it for cooking. The process is outdated but still relevant in many poor and backward regions of the world.

2.8.2 Indirect Extraction

The indirect extraction can broadly be done by converting the raw biomass directly to electricity or converting it to any other fuel type, solid, liquid, or gas.

Thermo-electric indirect extraction: This process works as the same principle as fossil-based fuels are fired for steam generation. Similarly, biomass is burnt to produce steam in the boilers, and the steam rotates the turbines for electricity generation. It's observed that with some technological advancements, the carbon emissions from biomass-based plants are less as compared to coal-based power plants.

Biomass to fuel indirect conversion

The Biomass can be converted to fuel broadly in two ways. One is the thermochemical conversion or the distillation, pyrolysis, or gasification process. Gasification produces synthetic gas; pyrolysis generates liquid (bio-oil). These fuels could be utilized for various further applications. The second way is the biological conversion process in which anaerobic digestion produces the natural gas (methane). Among these indirect processes, gasification is the most widely used process as it produces fuel that could be used readily.

2.9 Advantages and Disadvantages of Biomass Energy sources

2.9.1 Major Advantages of Biomass Energy

- It's a renewable source of energy and could be regenerated time and again.
- Its and native energy resource hence independent of foreign supply exchange.
- It supports the forest and agriculture-based industries which contribute to the country's economy.
- Carbon emissions from biofuels are comparatively much less compared to fossil-based fuels.
- The supply chain of biomass production and utilization helps in the waste management of wastes. The plant almost all the organic waste for energy production.
- It is not weather-dependent in nature.
- The production and availability could be controlled. The plants could operate even on low loads.

2.9.2 Major Disadvantages of Biomass Energy

- It produces mostly lower-grade energy due to low energy density.
- The land-intensive nature of biomass production makes it less feasible in regions with minimal forest or agricultural area.
- Biomass energy production is highly dependent on resource availability.
- Human resource is required in large numbers to collect biomass in the form of residuals and waste produced by various sectors.

Chapter 3 Solar as a Future Energy source

3.1 The Sun and its Dynamics in Solar Energy

Sun has always been dominant in the energy field, sometimes in direct form and sometimes-indirect forms. Earth's life expectancy is estimated to be years. All forms of fossil fuels are predicted to be exhausted by the coming few centuries of years. Thus, the prospects are mostly dependent on renewable sources, which are mostly dependent on the sun. The diameter of the sun is, and it has an internal energy generation source. This source supplies or radiates energy to not only the Earth but all the other planets as well. The sun's core temperature varies between the ranges of 8×10^6 K to 40×10^6 K. There are minimal observations on the sun's surface. The range of 1000-3000 KM is called the convective range, where irregular convective cells appear with a life of few minutes. This convective zone's outer layer is called the "Photosphere," which is the prime source of sun radiation. The photosphere is covered with a recessing layer of cool gas material spread over hundreds of kilometers range. Deep inside to the further layers of that lies the "Cornea." The cornea is the deep region with a temperature range of 10^6 K. All these layers of the Photosphere, Chromosphere, and Cornea form the group, which produces the solar radiation, which is evident on Earth.

Hydrogen (H) and Helium (He) are the two elements that constitute the "Plasma" of the sun. The physical fact that at very high temperatures, the electrons separate from nuclei. Plasma is such a state where this breakage takes place. During this

state, the transformation of Proton to Helium nuclei and energy is released simultaneously. This exothermal is highly energy-intensive and releases the energy of about 25.5eV. This energy from excess matter during the reaction is formed in the form of "electromagnetic radiation" and is later reaches Earth and other planets as "Solar energy."

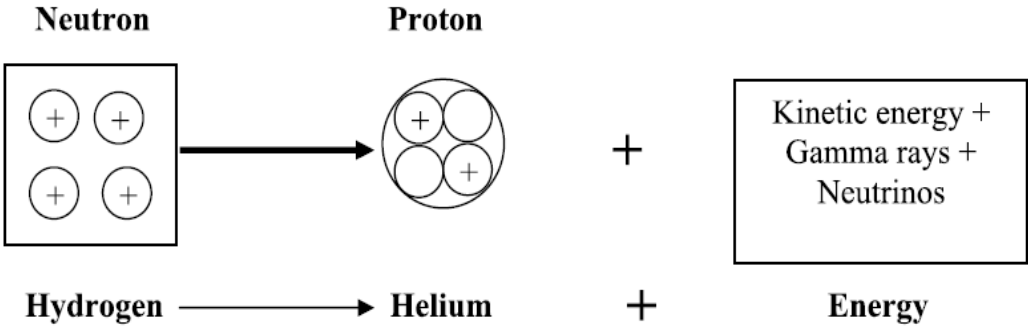
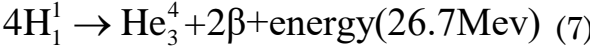

Figure 8. Reactions inside the sun

As we above in Figure 8, the transformation of protons to helium nuclei. There is a mass difference between the helium nuclei and the helium nucleus, which is less than the protons. The difference leads to electromagnetic radiation. "Solar wind" is generated because of these energy emissions along with some particles.

The basic working of the reactions taking place inside the sun is called "thermonuclear fusion." The energy produced during this reaction is about 3×10^{26} Watts. The conversion of hydrogen to helium takes place at the temperature of 1.5×10^6 K. The reaction occurring at the core of the sun is represented by the equation below:



In the Engineering world, the amount of solar radiation in any tropical region falling on the one-meter square surface is called 1KW. This is also known as "Solar irradiance," and the amount of solar irradiance depends on many governing factors such as elevation, altitude, weather conditions, etc. The sunshine hours for lower latitude regions are not so frequent. Most of these regions lie in developing nations,

and thus, solar energy utilization is more observed in such nations. The harnessing of solar energy can be comprised into three broad categories as mentioned below:

Photovoltaic Systems: In these systems, energy is utilized for direct electricity conversion

Photochemical Systems: In these systems, sunlight produces electricity or gaseous fuels

Photobiological Systems: The systems in which sunlight is converted to useful energy through biological organisms such as plants. Photosynthesis in plants is a good example of this category.

The sun radiates photons as light particles, which are received by all the celestial bodies. The Earth reflects at least one-third of the radiation received by the sun. The remaining part absorbed by the Earth is counted as more than enough to survive biological organisms. The Earth receives a wide range of wavelengths of radiation, from short ranges to ultraviolet rays.

3.2 Useful terminologies on Solar Radiations

- **Solar Constant (I_{sc}):** The amount of solar energy received from the sun on a unit area in a given unit time is termed as solar constant, and the universal value of the solar constant is 1367 W/m^2 .
- **Extra-terrestrial Radiations (I_{ext}):** The radiations that reach only the Earth's outer surface are known as Extra-terrestrial radiations, and the radiation which the sun emits fluctuates its intensity while moving towards Earth. Though the intensity varies, the wavelength of the radiation yet remains unchanged. It is denoted by (I_{ext}).

$$I_{ext} = I_{sc} [1 + 0.033 \cos(360n/365)] \text{ W/m}^2 \quad (8)$$

- **Terrestrial Radiations:** Due to the atmospheric characteristics of the Earth, most of the radiation is reflected back to space. Some of the radiations, which manage to reach the Earth's surface in the form of sunlight, are called Terrestrial radiations. Its unit is W/m^2 .

- **Solar Insolation:** It is the incident solar radiation on a given area on Earth at a given time. (J/m^2 or kWh/m^2)

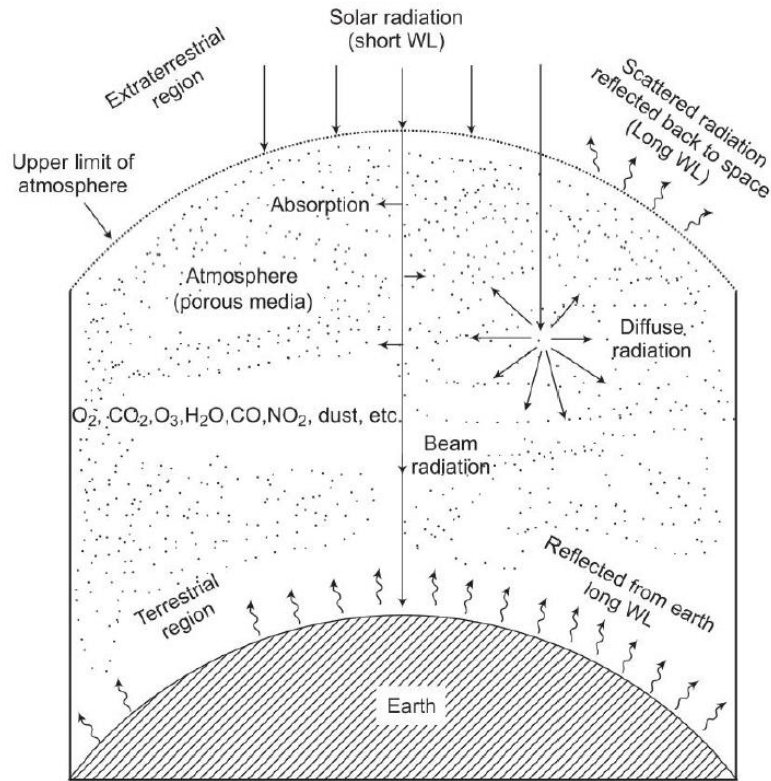

Figure.9. Solar radiation on Earth's atmosphere

The eccentricity of Earth: The position of the Earth's orbit and geometric parameters relative to the sun's positioning concerning the Earth is complex. To understand the spencer (1972) gave the expression of eccentricity, which is also known as the correction factor is expressed as below

$$\varepsilon = 1.00011 + 0.034221 \cos \theta + 0.001280 \sin \theta + 0.000719 \cos 2\theta + 0.000077 \sin 2\theta \quad (9)$$

$$\text{Where, } \theta = \frac{2\pi(N_d - 1)}{365} \text{ in radians}$$

Another equation for eccentricity by Duffe and Backman in 1991;

$$\varepsilon = 1 + 0.033 \cos \left(\frac{2\pi N_d}{365} \right) \quad (10)$$

Beam radiation: The type of radiation falling on Earth that reaches the Earth's surface directly without changing its direction is called Beam radiation.

Diffused radiation: The radiation in which the radiation gets deflected and scattered due to the reflection is known as Diffused radiation.

Global radiation: The combined total amount of radiation, including beam radiation and diffused radiation falling on Earth.

Air mass: It is the ratio of path length traversed by actual beam radiation towards Earth to the vertical path length of the atmosphere. Air mass is considered to be unity when the sun's position is at zenith.

$$\text{airmass (m)} = \frac{\text{Path length traversed by beam radiation}}{\text{Vertical Path length of atmosphere}}$$

3.3 Solar Radiation Measuring devices

Sunshine Hour Recorder: The device records the sunshine hours throughout the day.

Pyrheliometer: The device is used to measure only the beam radiation falling on the Earth's surface. In this device, a long tube is used to accumulate the beam radiation at incidence. Dry air is filled inside the tube to avoid absorption. It is mostly clubbed with a tracker for continuous recording.

Pyranometer: A pyrometer is a radiation measuring device to measure radiations of all wavelengths. It is a precision instrument that works on the sensors. It consists of two sensitive junctions one is hot and another cold. The readings are measured based on temperature difference among two junctions which is a function of radiation.

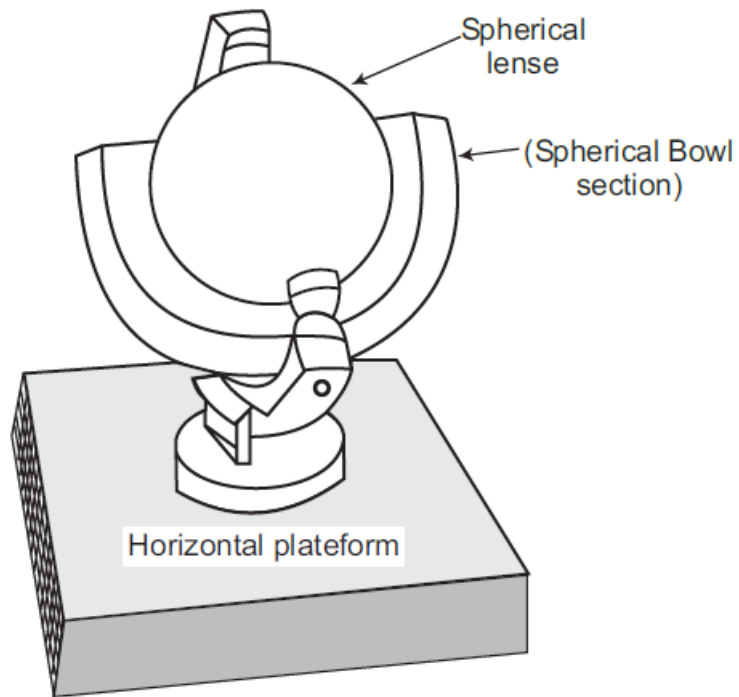

Figure. 10. Sunshine recorder

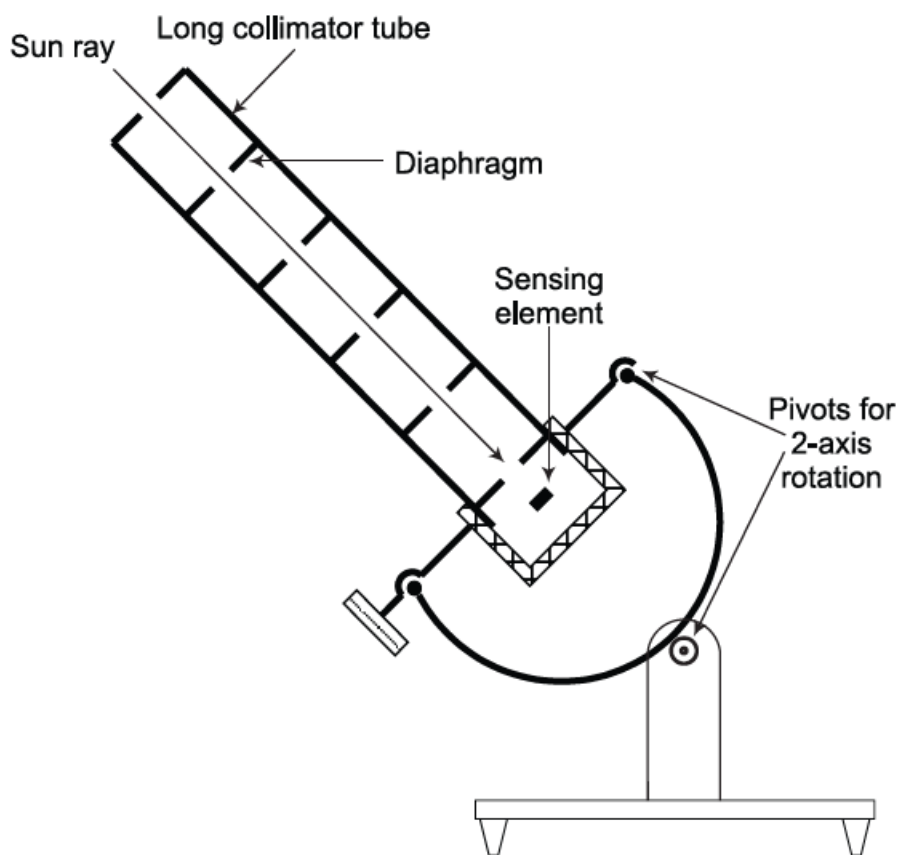

Figure.11. Pyrheliometer[2]

3.4 Useful geometrical Solar Angles

- **Latitude or Latitude Angle (Φ):** Latitude for a given location on Earth is the angle between the radial line (joining location to the centre of the Earth) and its projection on the equatorial plane of Earth. Mathematically, it is considered (+ve) for the northern hemisphere and (-ve) for the southern hemisphere.
- **Angle of Declination (δ):** Declination could simply be defined as the angular displacement of the sun from the equatorial plane of Earth. It can be calculated by the formula below:

$$\delta = 23.45 \times \left[\sin \frac{360}{365} (284 + n) \right] \text{ (Degrees) } \quad (11)$$

Where, n is the day of the year counted from the first of January

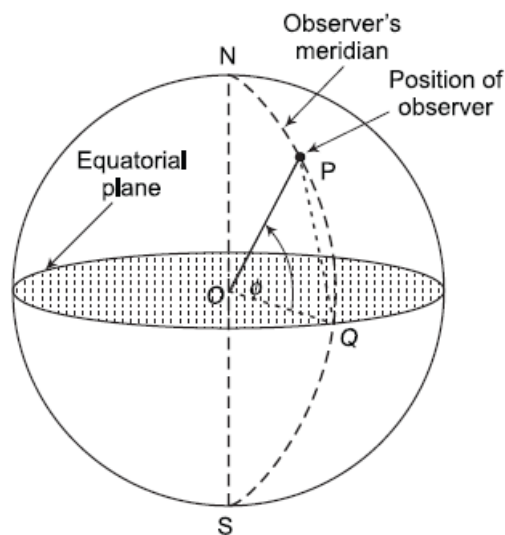

Figure 12. Latitude or Latitude angle (Φ)



Figure 13. Angle of Declination (δ)

- **Inclination angle (α):** The angle formed between the rays of the sun and its projection on a horizontal plane is known as the Inclination angle.
- **Solar Azimuth angle (γ_s):** The angle formed on the horizontal plane between the line due south and projection of the sun's rays on the horizontal plane is known as solar azimuth angle. It should be considered positive when measured from the south towards the west side.
- **Surface Azimuth angle (γ):** The angle between the line due south on the horizontal plane to horizontal projection of normal to the inclined plane surface. It is also considered positive when measured from the south towards the west.
- **Zenith Angle (θ_z):** The angle formed between the sun's rays and the normal drawn to the horizontal plane is known as the zenith angle.
- **Tilt Angle (β):** Tilt angle is the angle between the inclined plane surface and the horizontal in reference to it.

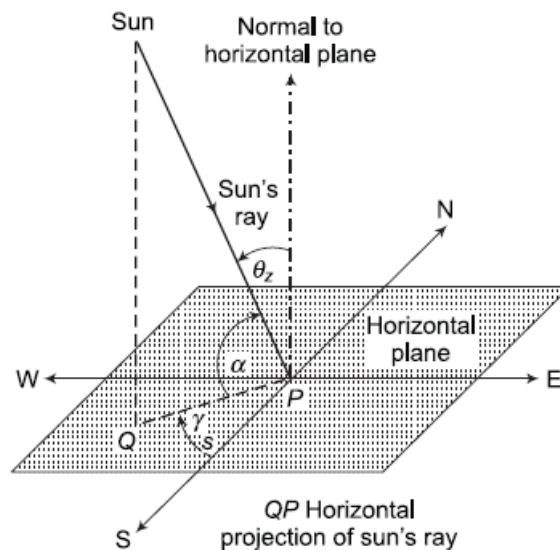

Figure 14. Inclination angle (α), Solar azimuth angle (γ_s) and Zenith angle (θ_z)

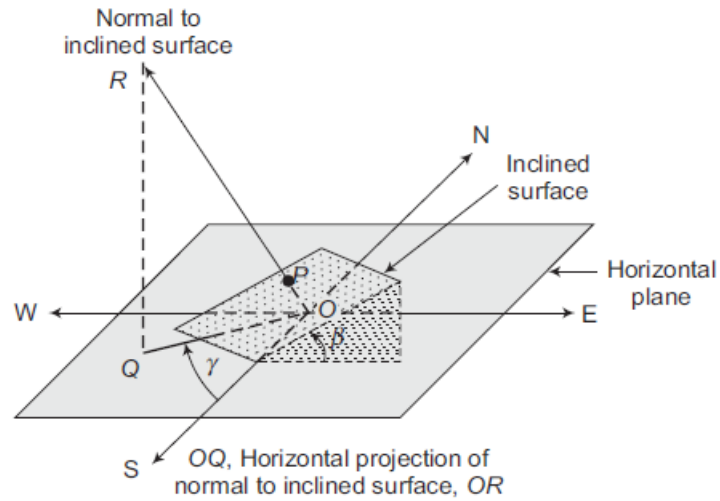

Figure 15. Tilt Angle (β) and Surface Azimuth angle (γ)[2]

- **Angle of incidence (θ_i):** The angle between sun's rays on the solar collector and the normal drawn to that surface is known as the angle of incidence. The incident angle can be calculated by the formula below:

$$\theta_i = \cos \delta \cos \omega (\cos \Phi \cos \beta + \sin \Phi \sin \beta \cos \gamma) + \cos \gamma \sin \omega \sin \beta \sin \gamma + \sin \delta (\sin \Phi \cos \beta - \cos \Phi \sin \beta \cos \gamma) \quad (12)$$

- Some notable cases

When surface is facing due south $\gamma = 0$

$$\cos \theta_i = \cos(\Phi - \beta) \cos \delta \cos \omega + \sin \delta \sin(\Phi - \beta) \quad (13)$$

When horizontal surface; $\beta = 0$ $\theta_i = \theta_z$

$$\cos \theta_z = \cos \Phi \cos \delta \cos \omega + \sin \delta \sin \Phi \quad (14)$$

When vertical surface facing due south $\gamma = 0$ $\beta = 90^\circ$

$$\cos \theta_i = -\sin \delta \cos \Phi + \cos \delta \cos \omega \sin \Phi \quad (15)$$

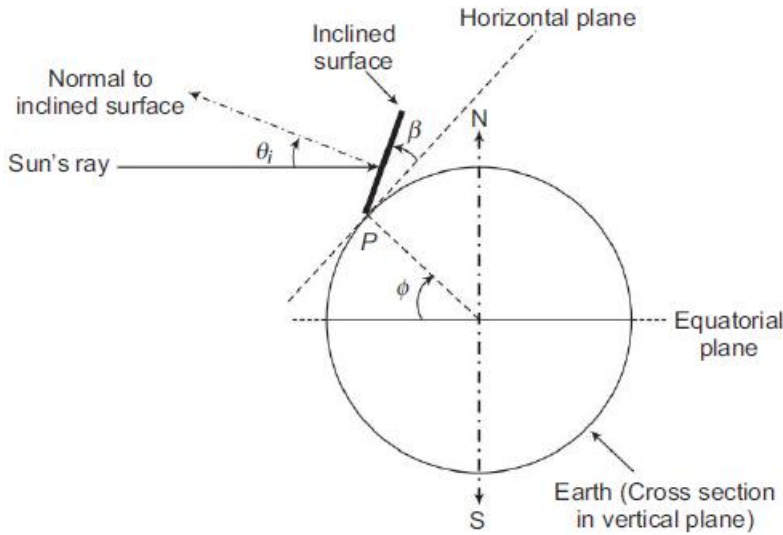

Figure 16. Latitude angle, Tilt angle and Angle of incidence

Hour Angle (ω): The Earth rotates on its axis, due to which the sun makes angular displacement due east or west from the local meridian. For any given time, the angle by which the Earth must rotate to bring the local meridian exactly in line with the observer's local meridian is known as the Hour angle. It is denoted by (ω) and can be calculated by the formula given below:

$$\omega = [12:00 - \text{Solar Time}] (\text{Hours}) \times 15^\circ \quad (16)$$

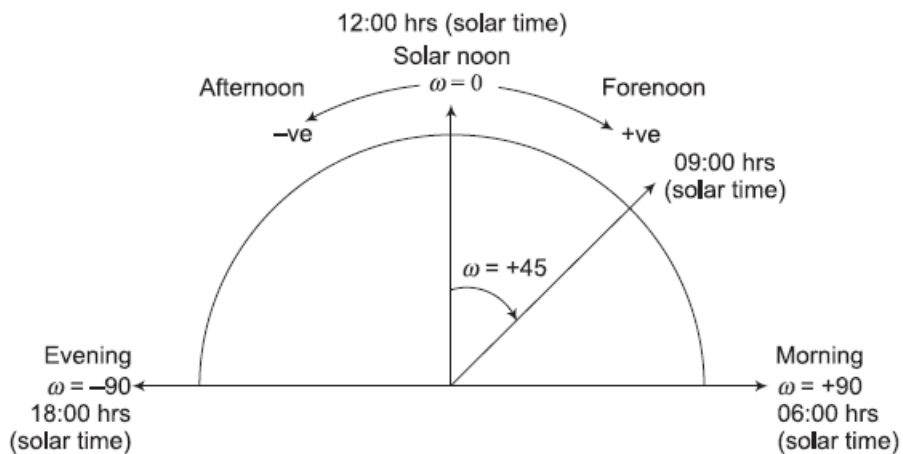

Figure 17. Hour Angle (ω) [2]

Solar Time: Solar time is based on the sun's angular movement across the sky and is always different from the local time of the place. The major use of solar time is to predict the sunray's direction towards Earth for a particular place. It is dependent on the longitude of the place under observation. Solar time also finds its usage in defining the rotation of the Earth with respect to the sun.

Chapter 4 Solar Photovoltaics

Solar Photovoltaics work on the basic principle of converting solar radiation to generate electricity using semiconductors. Among the many other solar energy generators, photovoltaics is considered to be the most efficient converter. The efficiency of solar photovoltaics lies in the range of 10%-25%, and also, the installation cost of the panels is still quite high. In comparison to the energy harnessed by fossil fuels, it's not yet competitive. However, with constant technological and engineering development, the operational costs and the panel costs have declined significantly in recent years.

The solar energy available to us is sufficient to fulfil the energy requirements of the Earth. The challenge lies in harnessing the capabilities of the technologies being developed. The sun releases 10^5 TW of Energy, which 10^4 is times the current consumption of Energy on Earth. Thus, the earlier advancements are made in technology, and the earlier humans can reduce the dependence on fossil fuels. Recently, many innovations have also been made in photovoltaic applications, making this technology promising in the coming future.

4.1 Why is Photovoltaics important?

- Photovoltaics have emerged as an important energy source for people living in remote areas where the electricity grids are very limited.
- The long-lasting span of almost 25 years makes solar panels with nominal maintenance quite user-friendly.
- Solar panels also play defining role in space exploration projects.
- Sometimes in some areas where regular electricity supply is impossible, e.g., deserts, mountains, seashores, etc., the small photovoltaics comes as a handy solution.
- Photovoltaics also emerged as a high-tech solution for charging small appliances such as watches, cameras, calculators, etc.
- Most importantly, it saves the Earth from global warming as its nonpolluting energy source.

4.2 Some limitations of Photovoltaics

- The cost of photovoltaic panels is yet not competitive to electricity charges of conventional sources.
- For a large scale, energy production from photovoltaic plants requires a huge land area.
- The power production from photovoltaics also depends on the solar radiation intensity of the place.
- Storage of the Energy produced is also an additional concern in photovoltaic plants.

Elements of silicon solar cell

- **Substrate:** A substrate is basically the P region of the cell base material. The main parameters of selection criteria for a substrate are (thickness 180-300 μm , doping, resistivity 1-2 Ωcm , and orientation).The substrate could possibly be single crystalline as well as multi crystalline.
- **Emitter:** An emitter is the N region of the cell material. It is basically formed by doping of silicon with some pentavalent impurities. These impurities could be arsenic, phosphorous, or antimony. The process of diffusing phosphorous usually takes place at a very high temperature (850 $^{\circ}\text{C}$ -1000 $^{\circ}\text{C}$).
- **Electrical Contacts:** Inside the photovoltaic cells, the contacts work as a bridge between the semiconductor and the external electrical load. These contacts can also be assumed as the front and back covering of the cell. The metallic portion which is not exposed to the sun's rays are called back contacts and are usually made up of aluminum. On the other hand, the front contact is the one that faces the light and is arranged as such to receive the photos in the N-region of the cell. For the collection of maximum current, the metal strips are spread all over the front surface. These metal strips are also known as fingers. Suppose the front contact is an extensive grid and has high shading, the conversion efficiency of the cell deteriorates. Hence, the shading should be minimum for maximum efficiency.

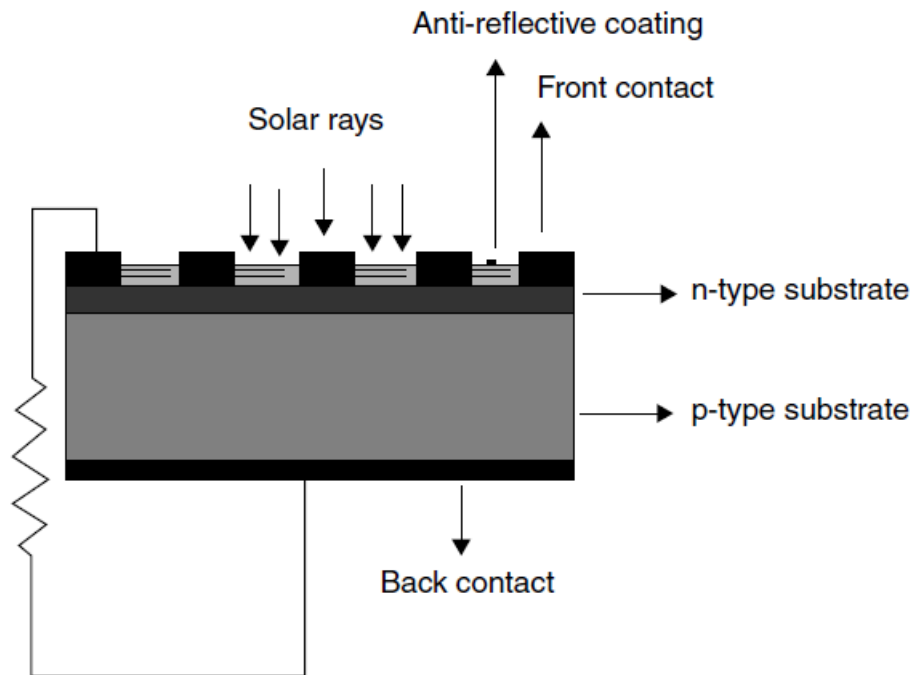

Figure.18 Elements of Photovoltaic cell[2]

- **Coatings:** The solar photovoltaic cells reflect a good portion of sun-rays to the atmosphere. To reduce this reflection so that maximum sun rays reach the cells, they are covered with Anti-reflective coatings. This allows the rays with optimum wavelength to enter the cell, which maximizes the overall efficiency of the cell. It has the capability to enhance efficiency by 3-4%. These coatings are generally made up of silicon dioxide or titanium dioxide.

4.3 Important Parameters of a Solar cell

- **Photons:** Photons have the capability to make the free electrons leave their atomic bonding inside the semiconductor. For the free-electron to leave the atomic bond, the photonic energy must be higher than bandgap energy. The extra amount of energy processed by the photons is expanded as heat during this process.
- **Bandgap Energy:** The semiconductor has the front contact as the silicon material. When the light falls of this surface, the free electrons start

dislocating. The amount of energy required to dislocate these free electrons from their covalent bond is known as Bandgap energy.

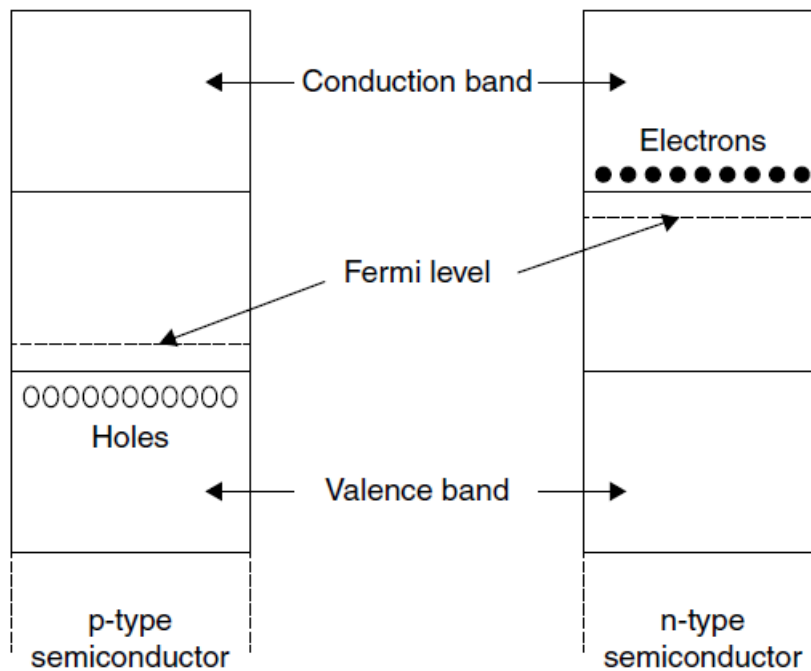

Figure.19 Energy band diagram of P-N Junction

- **Electron conduction:** During the circuit designing, it's recommended to keep the free-electron portion as close as possible to the junction. This design helps the free electrons to jump onto the conduction layer of the semiconductor easily. This design of the material is a herculean task but could improve the efficiency of the cell significantly.
- **Electrical resistance:** It is a critical engineering aspect in the designing and fabrication of solar cells. The property opposes the electric flow inside the cell leads to heating of the cell. If the "fingers" of the front contact grid are not placed adequately, it diminishes the current flow. This phenomenon reduces efficiency. The thickness of the grid fingers should be optimized to avoid this resistance. It shouldn't be too thick to create resistance and only thin enough for sunlight entry.

4.4 Major components of Photovoltaic systems

- **Module:** The substrate par which consists of the wired solar cells combined as the front contact with a glazing surface, is called the Module.
- **PV cell:** The photovoltaic cells are the semiconductors that emit current and voltage in exposure to sunlight.
- **Array:** When one or more modules are wired together and combined are called Array.
- **Battery Storage:** The storage facility for storing the DC current produced during the charging process.
- **Inverter:** An inverter must convert the direct current to the alternating current that the device is known as Inverter.
- **DC Load:** The devices which require direct current are DC loads
- **AC Load:** The devices which require alternating current are AC loads

4.5 Semiconductors in solar cells

Any solar cell is made up of crystalline silicon material. The silicon material consists of two regions P-Type and N-Type. The electric field is created when these two regions come in contact to generate current. The process is known as "Doping". In this doping process, an atom of foreign material is inserted to alter the material's properties. The material induced is called "Dopant," and it must have an odd number of valence electrons, e.g., three or five. This is because silicon has four valence electrons, and thus it creates an electric field.

4.6 Types of Semiconductors

- **P-Type semiconductors:** When the sunlight falls on a solar cell, the region it hits is called the P-region. The photons hitting the P- region should free as much as possible electrons from the layer. This is why the P-region is designed to be kept as close as possible to the junction so that the electrons can jump from the electric field to the conduction part to generate electric current.

- N-Type semiconductors:** In the N-Type semiconductors, the dopant used is phosphorous because it has five valence electrons in its atomic structure. The four electrons bond with the four available valence electrons of the silicon atom. This makes the possibility of one free electron when more phosphorous is doped and more free electrons are available. The N-region alone cannot create the electric field. Without an electric field, the jump of free electrons is not possible. Hence, both N-type and P-type semiconductors are crucial in forming an electric circuit to generate current.

4.7 Manufacturing of a Solar Cell

For the fabrication of solar cells, pure silicon is the basic material required. This pure silicon is fed inside a furnace for melting. After this, boron is added to the melted material, and a P-type crystal is withdrawn. Phosphorous, which is another dopant, is present in a gaseous state with N-type crystals. The basic p-type crystals are induced to this furnace of N-type crystals. Now the N-type crystals are diffused on the surface to produce the "P-N Junction." After this, the back and front contacts are framed around it to make a complete Solar cell.

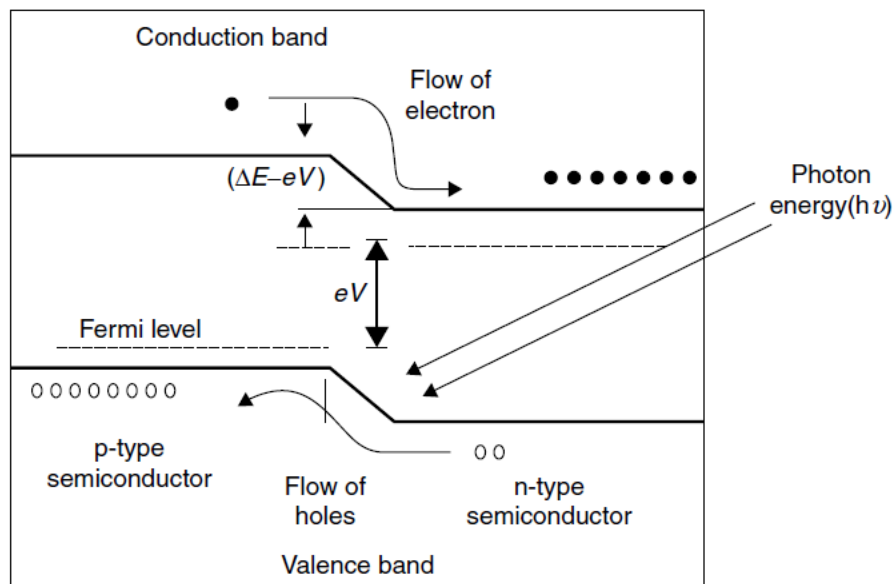

Figure20. Energy Band Diagram during excitation state

4.8 Some applications of Solar Photovoltaics

- **Solar Water Pumps:** The stand-alone photovoltaic systems are prevalent in rural agricultural small lands for pumping water into the fields. This kind of setup is mostly used by mid-level farmers and is extensively used in developing nations with good solar reception.
- **Space explorations:** The satellites revolving around the Earth and other space exploration vehicles utilize solar photovoltaic panels.
- **Solar vehicles:** The vehicles that use photovoltaics for running the vehicle's complimentary appliances are termed solar vehicles. This not necessarily means the driving force is based on energy from the solar panels.
- **Grid-based solar electricity:** All urban town setups distribute electricity through a grid setup. Nowadays, stand-alone grid setups are used to make housings self-dependent on electricity. Generally, these grids are of 10 KW capacity. The bigger power setup is of more than 10 MW power capacity.
- **Remote Lightning setups:** Sometimes, remote-controlled lighting setups use photovoltaics, as they are self-sufficient for the requirement. Mostly these systems find applications in illuminating remote roads, railway signals, traffic signals, etc.
- **Water treatment facilities:** Places that are too far away to take advantage of normal electricity supplies often face water purification problems as well. In such circumstances, stand-alone photovoltaic water treatment plants are set up to provide a healthy drinking water supply.

Chapter 5 Solar Thermal Collectors

Apart from solar photovoltaics, solar energy is extensively used in thermal applications as well. The solar radiation on the Earth's surface is in diffused form. To make thermal utility out of this radiation requires a higher temperature. This temperature raise could only be achieved by concentrating the sunrays at a point. These concentrated rays enhance the temperature of the liquid, oil, or gas. This high-temperature liquid or gas is later used for several applications. Normally, the

temperature rise observed in such collector setups lie in the range of 60-80 deg Celsius.

5.1 Applications of solar thermal collectors

Solar thermal collectors find applications in several places. Some of them are mentioned as below:

- **Solar Water Heating systems:** It works on an integrated component system and direct or indirect stand-alone module systems. Normally, water heating is used in countries which experience low temperature throughout the year.
- **Solar space heating:** Space heating is mostly done for conditioning the air inside any building or storage facility. The space heating could be water-based or air-based.
- **Solar refrigeration:** Solar refrigeration majorly works on adsorption or absorption depending on the available parameters and situation.
- **Industrial Heating:** Industrial solar heating ranges from low to high-temperature utility. Sometimes the applications require steam generation, then the temperature required is very high.
- **Desalination systems:** Solar desalination plants are extensively used in desalination, mostly in water-scarce areas. It could be in the form of solar stills or conventional desalinating models.
- **Thermal power generations:** These solar thermal power plants work on concentrating panels trough systems with a central tower receiving the heat. It also works on parabolic collectors with sterling engines.

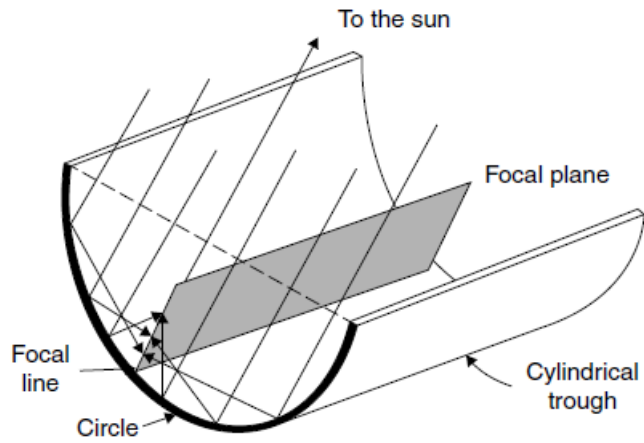

Figure.21 Cylindrical trough solar collectors

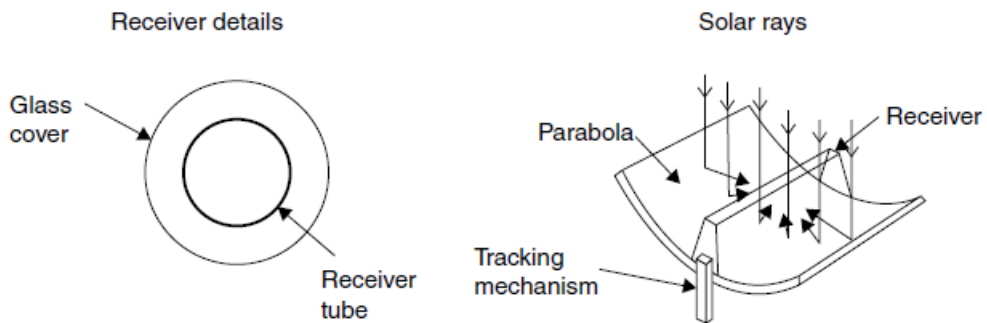
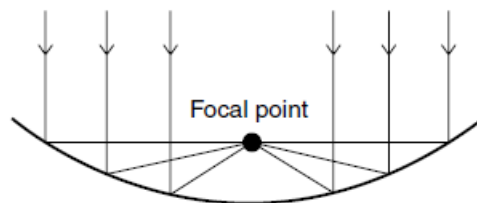
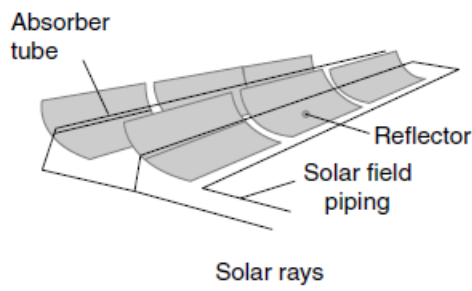

Figure 22. Schematic of parabolic trough reflector[2]

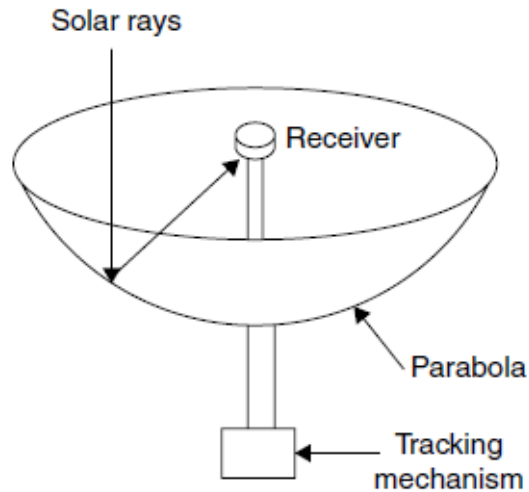

Figure 23. Schematic of parabolic dish type solar collector[2]

Chapter 6 Wind Energy

6.1 Windmill

If the wind kinetic energy is directly converted to mechanical energy, mechanically driven equipment such as setup is called a Windmill—for example, pumps, grinders, etc.



Wind mills



Wind turbines

6.2 Wind Turbine

Wind turbines consist of setup with huge shaft and rotatory blades. The setup works similarly to diesel engines or steam-based turbines. Though the working principle may be similar to the diesel engines, it has a big difference. The difference

lies in the fact that the output of the wind turbine is uncontrolled. The reason being the fluctuating variations in the input parameters.

Power calculations of wind.

The Power of the wind energy produced largely depends on the velocity of the wind. The Power of wind is defined by below given formula:

$$P = 1/2(\rho AV^3) \quad (17)$$

Where,

P = Power in watts

ρ = Density of air in (Kg / m^3)

A = Cross section area of wind passing through (m^2)

V = Velocity of the wind (m / s)

Power Law Relation: The wind speed is directly proportional to the Height above sea level. This relationship is modelled as below:

$$V_z = V_{10}(Z / 10)^\alpha \quad (18)$$

Where,

V_z = Wind speed at height z in (m)

V_{10} = Wind speed at Height of 10m (recommended)

α = Power law exponent varies in the range (0.1-0.6)

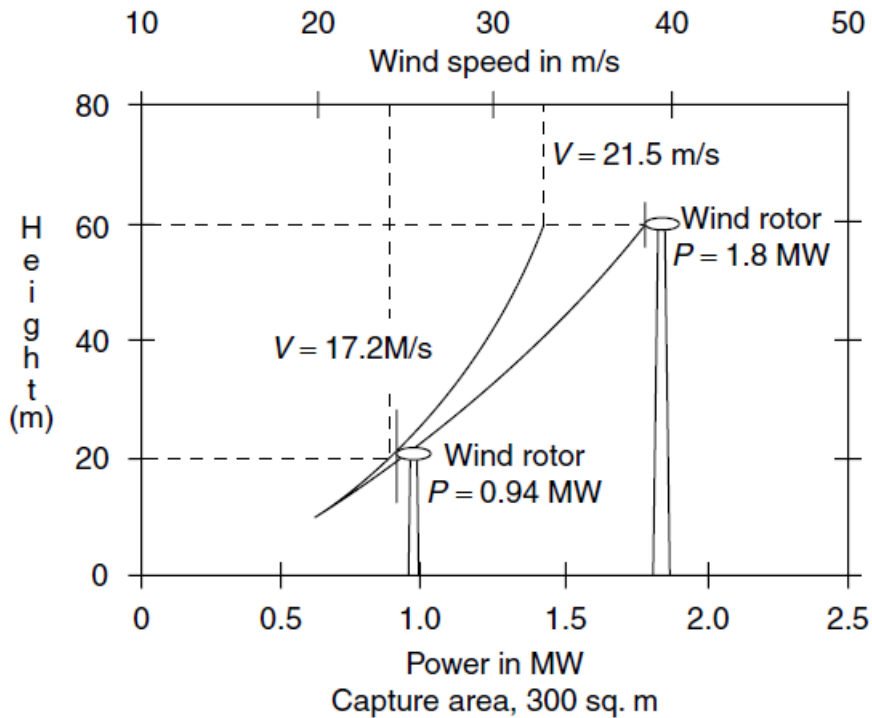

Figure.24 Relationship between wind power, speed and Height[2]

6.3 Site selection parameters for wind turbines

Various factors affect the site selection of wind turbines. The site selection should be cohesive to the wind turbine's smooth operations. Geographical features such as landscape properties have a major impact on operations. Some of the key parameters are discussed below.

- **Resistivity due to the Earth's surface:** In comparison to oceans, the Earth's surface is more resistant to wind flow. The reason being inequality in landscape and presence of trees, mountains, etc., resist the free flow of wind, which reduces the turbine's efficiency.
- **Hill effect:** when the wind blows along the hills, it hits the already existing wind along the hill's walls. Then when the wind reaches the top of the hill it's already at a higher speed. This effect of wind is called the "Hill effect." This is also the reason why most wind turbines are placed on hilltops.
- **Turbulent effect:** The nonuniformity in the wind speed arises due to several weather conditions. This causes a disturbance in the power output

of the turbines. If the weather conditions do not remain stable over a longer period of time, the turbine's overall efficiency suffers.

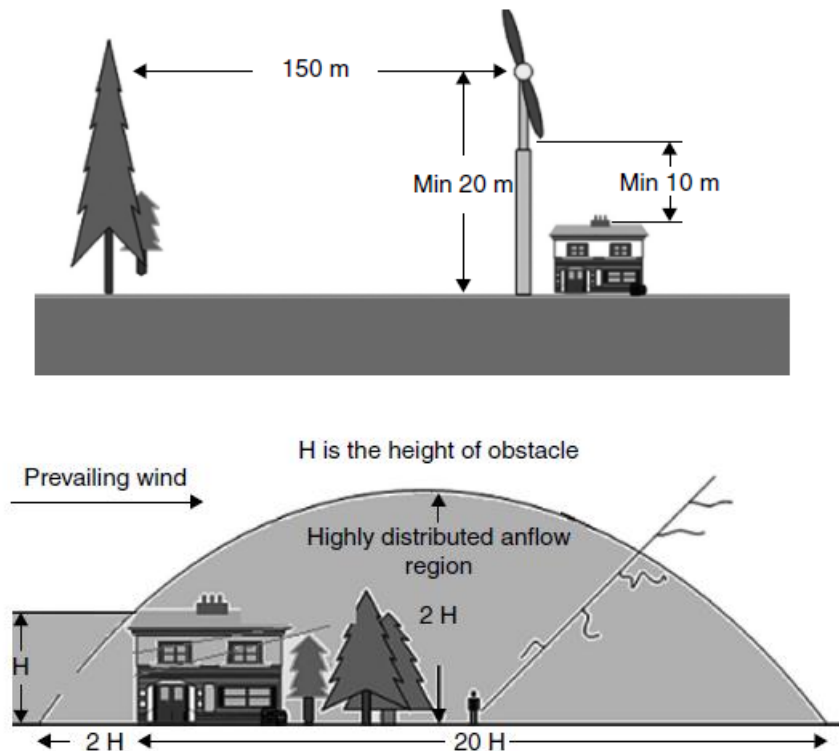

Figure25. Wind turbine location[2]

- **Tunnel effect:** The wind speed is higher when it passes through the narrow passage due to increased air pressure through the resistive walls. If the turbines are placed in the long valley of mountain ranges, it could take advantage of this wind flow called the "tunnel effect."
- **Sun's effect:** The sun is the hidden driving force of the wind patterns. If the sun doesn't heat the bodies on the Earth's surface, the wind speed is affected. This ambiguity may lead to the uneven power output from the turbines.
- **Wake:** It could be noticed that the wind turbines are located as a cluster in some areas. When the wind blows under the blade sweep, the wind speed is reduced. Sometimes when the speed is uneven, it creates turbulence. This effect is known as "wake," to avoid this wake, the wind turbines are placed at least three rotor diameters away from each other.
- **Wind Shear:** The topmost part of the blades sometimes experiences higher wind velocity than the bottommost region of the blade. Thus experiencing a

difference in the wind speed. This effect is known as "Wind shear" Too much wind shear can damage the turbine severely.

6.4 Classification of wind turbines

There are several kinds of wind turbines based on design and operations. The broad category of classification depends on the rotor axis of the turbine. The two major categories of turbines are discussed below.

- **Vertical Axis wind turbine:** In this type of turbine, the rotor axis is almost perpendicular to the mounting surface, also known as (VAWT). When the blades use the lift force to rotate the turbine, it's called (Darrieus), and when a drag force rotates it, it's called (Savonius).
- **Horizontal axis wind turbine:** When the turbine's rotor shaft is parallel to the surface of the mountings, it's called a Horizontal axis wind turbine (HAWT). These turbines are further classified as :
 - Dutch Windmills
 - Multiblade water pump mill
 - High-speed propeller machines

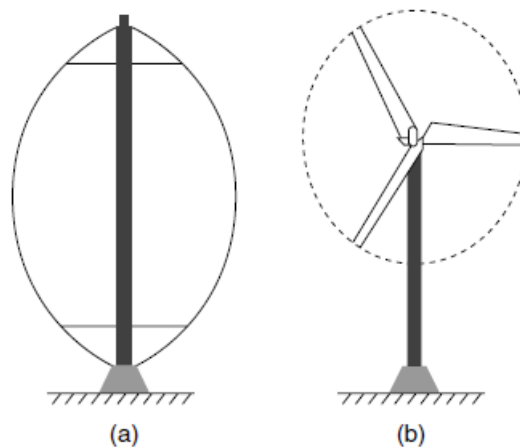

Figure 26. (a) Vertical Axis Wind Turbine (b) Horizontal Axis wind Turbine[2]

Advantages of vertical axis turbines:

- The vertical turbines are independent of the wind direction hence, they could be placed easily anywhere.
- The generators for VAWT are generally placed below the ground, which supports easy maintenance of the machines.

- The Height of vertical axis turbines is not so high, saving the bird accidents due to turbines.
- The VAWT doesn't make noise and is efficient for the urban residential complex housings.

Disadvantages of vertical axis turbines:

- The Height of the vertical turbines is very less which reduces the efficiency.
- The inefficiency of dragging in blades is quite frequent in them.
- The VAWT cannot be installed on long height towers as it needs solid ground for mounting.

Advantages of Horizontal axis turbines:

- The horizontal axis turbines have better stability as the blades are placed towards the turbine's center of gravity.
- The blades of horizontal turbines have a better angle of attack.
- The Height of these turbines is very high, enhancing the wind flow and increasing the turbine's overall efficiency.
- The blades' Pitch ability helps the turbines overcome wind storms and withstand such high wind blowing speeds in adverse conditions.
- Overall high efficiency is observed than the vertical axis turbines due to the full blade movements and its conversion to power output.
- These turbines are self-starting and could be placed in offshore locations and forests as well.

Disadvantages of Horizontal axis turbines

- The installations of HAWT are mostly in remote places and require huge investments for setup.
- The transportation of huge blades, gearboxes, and shafts need skilled experts for installations.
- Turbulence in the wind could damage the blades in some cases.
- The maintenance of these turbines is quite difficult as the rotor shafts are at a height.

6.5 Wind Energy Conversion principle

All the wind turbines work on the principle of the "Lift" and "Drag" concept. Both HAWT and VAWT work on these principles, which are discussed below briefly.

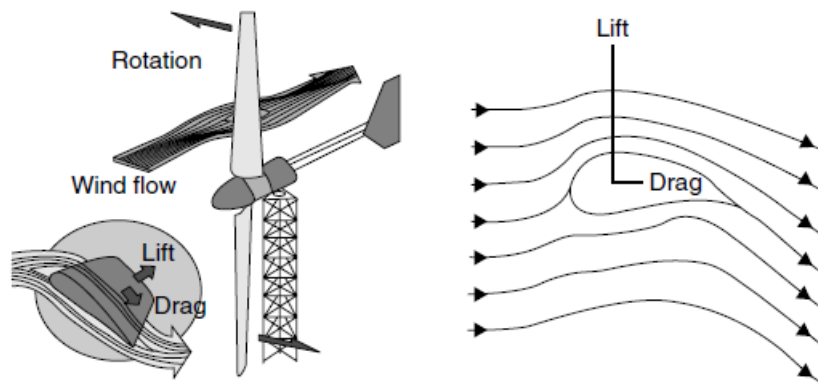

Figure 27. Concept of LIFT and DRAG[2]

Concept of LIFT force: Any wind flow creates an airfoil around the turbine. The force which acts vertically to the airflow is known as LIFT force. It depends on the laminar flow of the airfoil. In any airfoil, the winds on the top move faster in order to cover the long-distance as compared to the wind at the bottom of the foil. This pressure difference gives rise to the lift force in the airfoil. If there is any turbulence in the flow there will be no lift force or very nominal. The lift is caused by the Bernoulli's effect creating low pressure at the bottom of the air foil.

$$C_L = \frac{[F_L / S_L]}{[1/2(\rho V^2)]} \quad (19)$$

Where,

C_L = Lift Coefficient

F_L = Lift Force in Newton

S_L = Cross sectional area of airfoil in m^2

ρ = Air density kg / m^3

V = Wind Velocity in m / s

Concept of DRAG force: When any body is exposed to wind flow the propulsion it faces due to the wind is the "Drag" force. This force acts in the direction of the wind flow. The drag force depends on the angle of attack as well, which is the angle made by the rotor blade with the direction of the wind stream.

Similar to the Lift coefficient the Drag coefficient is given as;

$$C_D = \frac{[F_D / S_D]}{[1/2(\rho V^2)]} \quad (20)$$

Where,

C_D = Coefficient of Drag Force

F_D = Drag Force in Newton

S_D = Cross sectional area of airfoil in m^2

ρ = Air density kg / m^3

V = Wind Velocity in m / s

Chord Line: The straight line connecting the leading and trailing edges of the airfoil are called chord lines. The plane of rotation is nothing but the plane in which blade tips lie.

Pitch angle (β): The angle made between the chord line of the blade and the plane of rotation is known as pitch angle. The pitch angle is static in nature and depends only of orientation of the blade.

Angle of attack (γ): It is the angle between the chord line of the blade and the effective direction of airflow.

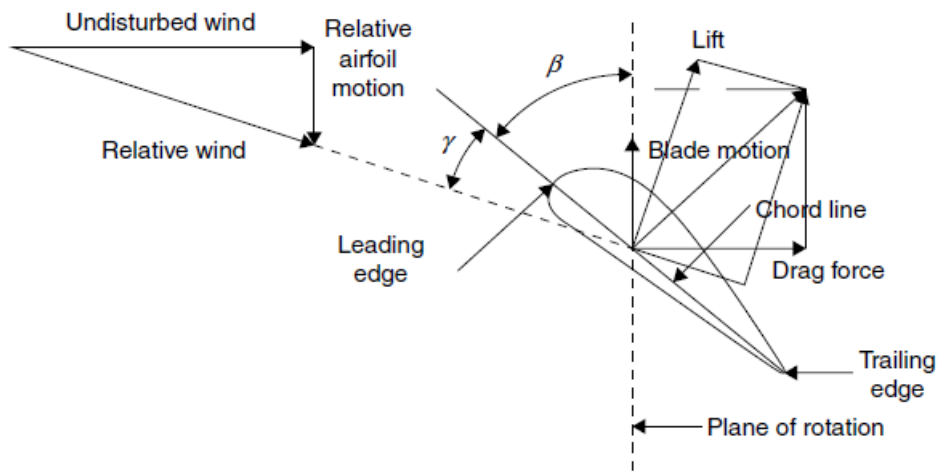

Figure 28. Chord Line, Pitch angle and Angle of attack[2]

Chapter 7 Nuclear power

From a simplified, technical point of view, a nuclear reactor is a sort of nuclear boiler producing steam, which is sent to a turbine that moves a generator, hence producing electricity. Nuclear reactors operate on the principle of nuclear fission, the process in which a heavy atomic nucleus splits into two smaller fragments. The nuclear fragments are in very excited states and emit neutrons, other subatomic particles, and photons. The emitted neutrons may then cause new fissions, which in turn yield more neutrons, and so forth (ref Fig 29.). Such a continuous self-sustaining series of fissions constitutes a fission chain reaction. A large amount of energy is released in this process, and this energy is the basis of nuclear power systems[7].

The fissioning of atoms in the chain reaction also releases a large amount of energy as heat. The generated heat is removed from the reactor by a circulating fluid, typically water. This heat can then be used to generate steam, which drives turbines for electricity production. In order to ensure the nuclear reaction takes place at the right speed, reactors have systems that accelerate, slow or shut down the nuclear reaction, and the heat it produces. This is normally done with control rods, which typically are made out of neutron-absorbing materials such as silver and boron.

7.1 Reactor fuel

A number of different materials can be used to fuel a reactor, but most commonly uranium is used. Uranium is abundant and can be found in many places around the world, including in the oceans. Other fuels, such as plutonium and thorium, can also be used[8].

Uranium is the most widely used fuel by nuclear power plants for nuclear fission. Nuclear power plants use a certain type of uranium U-235 as fuel because its atoms are easily split apart. Although uranium is about 100 times more common than silver, U-235 is relatively rare at just over 0.7% of natural uranium. Uranium concentrate is separated from uranium ore at uranium mills or from a slurry at in-situ leaching facilities. It is then processed in conversion and enrichment facilities,

which increases the level of U-235 to between 3%–5% for commercial nuclear reactors and made into reactor fuel pellets and fuel rods in reactor fuel fabrication plants. Most of today’s reactors contain several hundred fuel assemblies, each having thousands of small pellets of uranium fuel. A single pellet contains as much energy as there is in one tonne of coal. A typical reactor requires about 27 tonnes of fresh fuel each year. In contrast, a coal power station of a similar size would require more than two-and-a-half million tonnes of coal to produce as much electricity

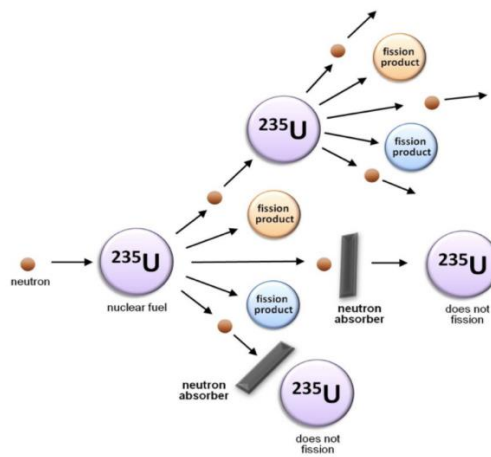

Figure 29. Schematic representation of a controlled nuclear chain reaction – note that the neutron absorbers block two of the fission pathways.

7.2 Components of a nuclear reactor

There are several components common to most types of reactor:

Moderator

Material in the core which slows down the neutrons released from fission so that they cause more fission. It is usually water but may be heavy water or graphite.

Control rods or blades

These are made with neutron-absorbing material such as cadmium, hafnium or boron, and are inserted or withdrawn from the core to control the rate of reaction,

or to halt it.* In some PWR reactors, special control rods are used to enable the core to sustain a low level of power efficiently. (Secondary control systems involve other neutron absorbers, usually boron in the coolant – its concentration can be adjusted over time as the fuel burns up.) PWR control rods are inserted from the top, BWR cruciform blades from the bottom of the core.

Coolant

A fluid circulating through the core so as to transfer the heat from it. In light water reactors the water moderator functions also as primary coolant. Except in BWRs, there is secondary coolant circuit where the water becomes steam. (See also later section on primary coolant characteristics.) A PWR has two to four primary coolant loops with pumps, driven either by steam or electricity – China's Hualong One design has three, each driven by a 6.6 MW electric motor, with each pump set weighing 110 tonnes.

Pressure vessel or pressure tubes

Usually a robust steel vessel containing the reactor core and moderator/coolant, but it may be a series of tubes holding the fuel and conveying the coolant through the surrounding moderator.

Steam-generator

Part of the cooling system of pressurised water reactors (PWR & PHWR) where the high-pressure primary coolant bringing heat from the reactor is used to make steam for the turbine, in a secondary circuit. Essentially a heat exchanger like a motor car radiator. Reactors have up to six 'loops', each with a steam generator. Since 1980 over 110 PWR reactors have had their steam generators replaced after 20-30 years' service, over half of these in the USA.

Containment

The structure around the reactor and associated steam generators which is designed to protect it from outside intrusion and to protect those outside from the effects of radiation in case of any serious malfunction inside. It is typically a metre-thick concrete and steel structure. Newer Russian and some other reactors install

core melt localisation devices or 'core catchers' under the pressure vessel to catch any melted core material in the event of a major accident.

7.3 Types of nuclear reactors

A nuclear reactor releases nuclear energy in the form of heat; the heat is used to generate steam, and the steam to generate electricity. More than 80% of the nuclear power plants in operation nowadays belong to the pressurised water reactor (PWR) or to the boiling water reactor (BWR) type (see fig. 2). Both of them use water as moderator to slow down (thermalize) the neutrons to increase the fission probability of ^{235}U , as well as fluid to cool the fuel. The main difference is that in PWRs the water is kept in liquid phase by high pressure (155 bar), to enhance the moderation feature, hence a secondary circuit is needed to produce the steam, while in BWR the steam is generated directly into the primary circuit and sent to the turbine. The nuclear fuel is usually in the form of UO_2 pellets, 8 mm diameter and 12 mm height, piled up into zircalloy cladding cylinders 3.5 m length. A square matrix 8×8 (BWR) or 17×17 (PWR) of those fuel rods forms one single fuel assembly. According to the size of the reactor, hundreds of fuel assemblies form the nuclear core, to be cooled by the water. The shutdown control rods, the water cooling and the water injecting systems are the main safety systems connected to the primary and secondary circuits (only for PWRs) of the reactor.

The last barrier to avoid radioactive release towards the environment is the safety containment system. Usually in PWRs a steel or a concrete containment is provided, able to withstand the maximum pressure and temperature created by the steam released by the primary cooling system into the building during a loss-of-coolant accident. In BWRs a different strategy is adopted: the steam is released into a dry-well chamber, then directed into a wet-well chamber by means of large piping that guide the steam into a suppression water pool, where it is condensed. Both the containments have to withstand also to external accidents, ranging from natural (tornadoes, floods, earthquakes) to manmade (airplane crash) events.

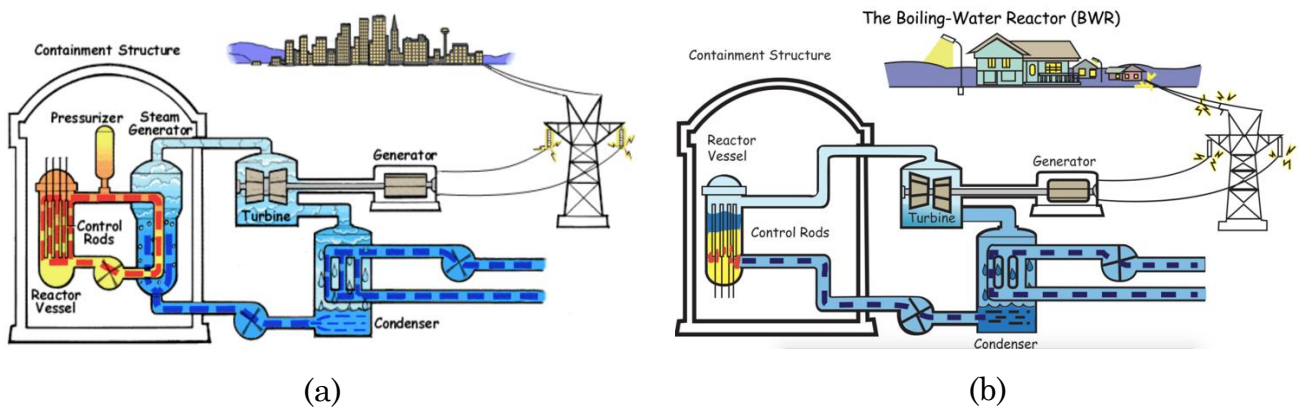

Figure 30. Schematic diagram of the (a) pressurised water reactor (PWR) and (b) boiling water reactor (BWR).

7.4 Power rating of a nuclear power plant

Nuclear plant reactor power outputs are quoted in three ways:

- Thermal MWt, which depends on the design of the actual nuclear reactor itself and relates to the quantity and quality of the steam it produces.
- Gross electrical MWe, which indicates the power produced by the attached steam turbine and generator, and also takes into account the ambient temperature for the condenser circuit (cooler means more electric power, warmer means less). Rated gross power assumes certain conditions with both.
- Net electrical MWe, which is the power available to be sent out from the plant to the grid, after deducting the electrical power needed to run the reactor (cooling and feedwater pumps, *etc.*) and the rest of the plant

The relationship between these is expressed in two ways:

- Thermal efficiency %, the ratio of gross MWe to MWt. This relates to the difference in temperature between the steam from the reactor and the cooling water. It is often 33-37% in light water reactors, reaching 38% in the latest PWRs.

- Net efficiency %, the ratio of net MWe achieved to MWt. This is a little lower, and allows for plant usage.

In World Nuclear Association information pages and figures and World Nuclear News items, generally net MWe is used for operating plants, and gross MWe for those under construction or planned/proposed.

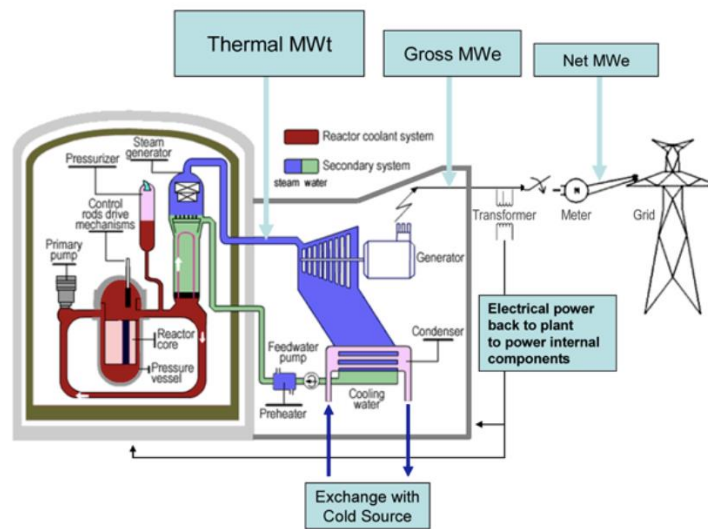

Figure 31. Power rating of a nuclear power plant.

7.5 Basics of nuclear safety

Since the beginning of the development of the nuclear energy, the nuclear safety is founded on the concept of “defence-in-depth”. A consecutive set of safety barriers, both of technological and operational type, is created around the source of the hazard, i.e. the nuclear fuel containing the highly radioactive isotopes. The first barrier is the fuel matrix itself: the synthesised, ceramic UO₂ is selected to accommodate a large part of the gaseous fission products into its porosity, and to resist to the temperature reached by the fuel during the normal operation and to

the neutron flux, which has the capability to change the material structure. The second barrier is represented by the fuel cladding, the third is the primary system boundary and the fourth is the containment building. A further level of safety is offered by the set of safety systems connected to the primary, the secondary and the containment systems. Redundancy, separation and diversification are the key requirements, to reduce the risk of failure. Even if one single safety system is enough to cope with a specific accident, a multiplicity of two, three or even four is usually envisaged (redundancy). Moreover, different types of safety systems are adopted to obtain the same function (diversification). The first safety system is the shutdown control rods system, to stop the reaction chain. A second is the decay heat removal system, to avoid fuel overheating. A third is the safety injection system, to keep the core cooled even in case of a break in the primary circuit, leading to a loss of coolant. A fourth is the containment spray system, to condensate the steam inside the pressure containment building. The same system is envisaged also inside the reactor pressure vessel for the BWRs. The last operational barrier is represented by the emergency planning procedures, adopted to manage or evacuate the surroundings of the nuclear power plant in case all the previous safety barriers suffer some faults. Both a deterministic and a probabilistic approach are followed in the design and the evaluation of the safety level of a nuclear reactor. The main goal is to minimise the risk of accident and to provide a suitable set of safety systems to cope with all the different and possible accident scenarios that may occur, in case of internal or external initiating events, natural or man-made. But the real, estimated risk is usually different from the risk perception. So it is not surprising if the nuclear energy is perceived as less safe than the other energy sources or even other, daily-life human activities. Statistical data are anyway available in the literature, so a scientifically and technically based comparison can be performed. Again it would not be surprising, after that analysis, to see that to live around a nuclear power station is less risky than to be hit by lightning having a tour on the mountains, or to die at home due to a domestic accident or to die due to a collision while driving our own car.

7.6 Nuclear Energy Economic Sustainability and Insurability

Although nuclear power has many potential challenges as outlined above, perhaps the most difficult to overcome is simply economics. Nuclear power plants have become notorious for high construction costs—as many projects throughout the world have resulted in construction costs that doubled or tripled the original estimate, followed by frequent and expensive repairs. This was the fundamental reason for the dearth of new nuclear power plant orders in the last few decades. The world's economy, however, is far from a free market, so it is possible to influence the cost of nuclear power using government regulation and subsidies. Overall, the nuclear industry has been heavily subsidized by many governments since WWII, but is yet to be competitive on its own without subsidies. Despite the majority of direct and indirect subsidies for over 50 years, the average cost of electricity generation from nuclear power is in the range of \$5,000 per kW of capacity. This could be argued by climate change mitigation advocates as sufficient, if there were not already other alternative energy sources to the pollution of fossil fuels that now have lower costs. For example, solar energy is already a less expensive alternative in some parts of the U.S. in the current subsidized landscape and the levelized cost of electricity from solar photovoltaic-generated electricity in particular has dropped precipitously in the last year to be competitive with grid electricity in many regions without subsidies.

An illustration of how serious an economic challenge nuclear energy poses, lies in the fact that insurance agencies refuse to cover full liability and indemnity for nuclear utilities in case of a nuclear accident. This is primarily because in the case of a catastrophic nuclear accident, the sheer magnitude of such a devastating event would likely bankrupt any company (or companies) held responsible. Therefore, to make nuclear power generations possible, governments worldwide have to guarantee they will cover any exceeding costs past a certain liability cap, and thus any liabilities in excess of an arbitrary financial cap are covered by the taxpayer of the given country. Thus, the nuclear power industry is relieved of any liability beyond the insured amount for any incident involving radiation or radioactive

releases regardless of the fault or the cause. Trebilcock and Winter point out how such incomplete insurance liability can act as a disincentive for safety, and in addition skew the economics of nuclear viability as the industry is not responsible for full damages. Initially, such laws like the Price-Anderson Nuclear Industries Indemnity Act (PPA) in the U.S, were intended to be temporary, as it was assumed that once the companies had demonstrated a record of safe operation, they would be able to obtain insurance in the private market. This did not happen. As former U.S. Vice-President Dick Cheney pointed out in 2001, without the PPA “nobody’s going to invest in nuclear power plants”. Even today, nuclear power remains un-insurable in the free market [9] and governments have had to provide some form of limited liability for nuclear utilities for any company to consider building a reactor. Largely depending on the geographic location of the nuclear power plant, the devastating economic consequences of a catastrophic nuclear accident are in the order of hundreds of billions. Thus, the U.S. Nuclear Regulatory Commission (NRC) concluded that the liability limits were sufficiently significant to constitute a “subsidy”; however, a quantification of the amount of this nuclear insurance subsidy was not attempted. This area of inquiry needs additional research, however, recent preliminary work indicates that if only this one indirect subsidy for nuclear power was diverted to photovoltaic manufacturing, it would result in more installed power and more energy produced by mid-century compared to the nuclear case. The numbers of such a subsidy shift are substantial as by 2110 cumulative electricity output of solar are predicted to provide an additional 48,600 TWh of energy over nuclear valued at more than \$5 trillion. The results clearly show that not only does the indirect insurance liability subsidy play a significant factor for the viability of the nuclear industry, but also how the transfer of such an indirect subsidy from the nuclear to other technically viable alternative energy sources would result in more energy and more financial returns over the life cycle of the technologies.

Chapter 8 Hydropower

Hydropower is a clean, efficient and hassle-free technology of power generation. The basic principle of the hydro power generation is impulse momentum. Water potential is converted into the mechanical energy by rotating the turbine and mechanical energy is further converted into the electrical energy by using generator. The block diagram of converting the hydro energy is shown in Fig. 3. The mechanical energy produced by the turbine shaft is given as:

$$P = q \cdot \rho \cdot g \cdot h \cdot \eta \quad (21)$$

where η is the hydraulic efficiency of the turbine, q is discharge of water in m^3/s , h is head in m, g is gravitational acceleration in m/s^2 , and ρ is water density in kg/m^3 . Hydro power plant has various components which can be categorized as civil and electro-mechanical components. These components have their own function and these functions are interconnected to each other so that there is need for proper operation of each component in order to achieve maximum electricity generation with utilization of available potential. In small hydro power run of river scheme, water is diverted from the river by the diversion weir. The dam is constructed across the river, which maintains a continuous flow through the intake. Water is then passed through the desilting tank in which sand particles are settled down. The water leaving from the desilting tank goes to the forebay tank through a channel and from the forebay tank water is passed to the turbine through the pressure pipe known as penstock. Water carried by penstock directly strike on the turbine blade followed by the guide vanes to rotate the turbine runner. The runner of the turbine is coupled with the shaft and this shaft also coupled with the generator to produce the electricity. Generally hydraulic turbine has efficiency up to the range of 94–95% and overall efficiency of the hydro power plants can be up to 88–90%.

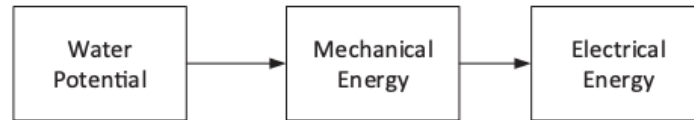

Figure 32. Block diagram of hydropower generation.

The operation of hydro power plants should be economic, reliable and generate maximum energy. In the operation of hydro power plants, it is possible to optimize the efficiency, energy generation and cost effectiveness of water use with imbalances in inflows and demands. The large costs of establishing, maintaining and operating hydropower plants have also encouraged for the optimal design and operation of run of river power plants through existing approaches. The operation of hydropower plants also involves the scheduling of production units in every time interval.

8.1 Classification of hydropower plants

Hydropower plants are often classified in three main categories according to operation and type of flow. Run-of-river (RoR), storage (reservoir) and pumped storage HPPs all vary from the very small to the very large scale, depending on the hydrology and topography of the watershed. In addition, there is a fourth category called in-stream technology, which is a young and less-developed technology. The different types of hydropower plants is discussed in the following section.

8.1.1 Run-of-River

A RoR HPP draws the energy for electricity production mainly from the available flow of the river (fig33). Such a hydropower plant may include some short-term storage (hourly, daily), allowing for some adaptations to the demand profile, but the generation profile will to varying degrees be dictated by local river flow conditions. As a result, generation depends on precipitation and runoff and may have substantial daily, monthly or seasonal variations. When even short-term

storage is not included, RoR HPPs will have generation profiles that are even more variable, especially when situated in small rivers or streams that experience widely varying flows. In a RoR HPP, a portion of the river water might be diverted to a channel or pipeline (penstock) to convey the water to a hydraulic turbine, which is connected to an electricity generator (see Figure 33). RoR projects may form cascades along a river valley, often with a reservoir-type HPP in the upper reaches of the valley that allows both to benefit from the cumulative capacity of the various power stations. Installation of RoR HPPs is relatively inexpensive and such facilities have, in general, lower environmental impacts than similar-sized storage hydropower plants.

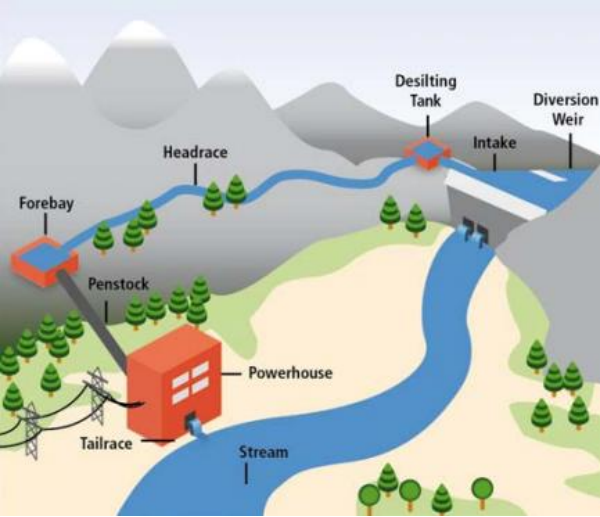

Figure 33. Run-of-river hydropower plant.

8.1.2 Storage Hydropower

Hydropower projects with a reservoir are also called storage hydropower since they store water for later consumption. The reservoir reduces the dependence on the variability of inflow. The generating stations are located at the dam toe or further downstream, connected to the reservoir through tunnels or pipelines. (Figure 34). The type and design of reservoirs are decided by the landscape and in many parts of the world are inundated river valleys where the reservoir is an artificial lake. In geographies with mountain plateaus, high-altitude lakes make up another kind of reservoir that often will retain many of the properties of the

original lake. In these types of settings, the generating station is often connected to the lake serving as reservoir via tunnels coming up beneath the lake (lake tapping). For example, in Scandinavia, natural high-altitude lakes are the basis for high pressure systems where the heads may reach over 1,000 m. One power plant may have tunnels coming from several reservoirs and may also, where opportunities exist, be connected to neighbouring watersheds or rivers. The design of the HPP and type of reservoir that can be built is very much dependent on opportunities offered by the topography.

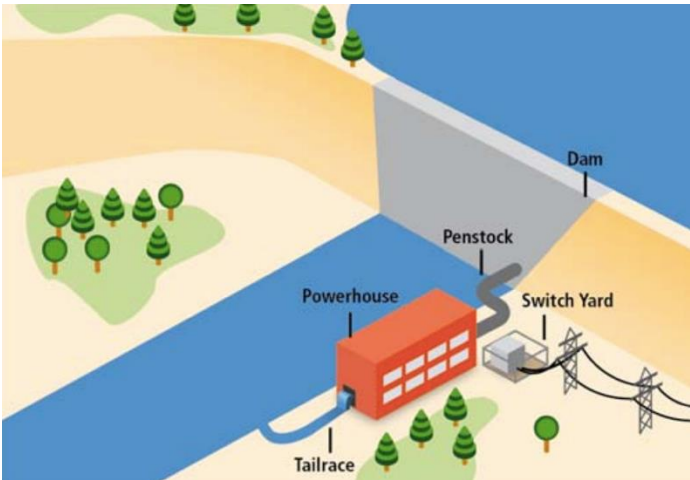

Figure 34. Typical hydropower plant with reservoir.

8.1.3 Pumped storage

Pumped storage plants are not energy sources but are instead storage devices. In such a system, water is pumped from a lower reservoir into an upper reservoir (Figure 35), usually during off-peak hours, while flow is reversed to generate electricity during the daily peak load period or at other times of need. Although the losses of the pumping process make such a plant a net energy consumer overall, the plant is able to provide large-scale energy storage system benefits. In fact, pumped storage is the largest capacity form of grid energy storage now readily available worldwide.

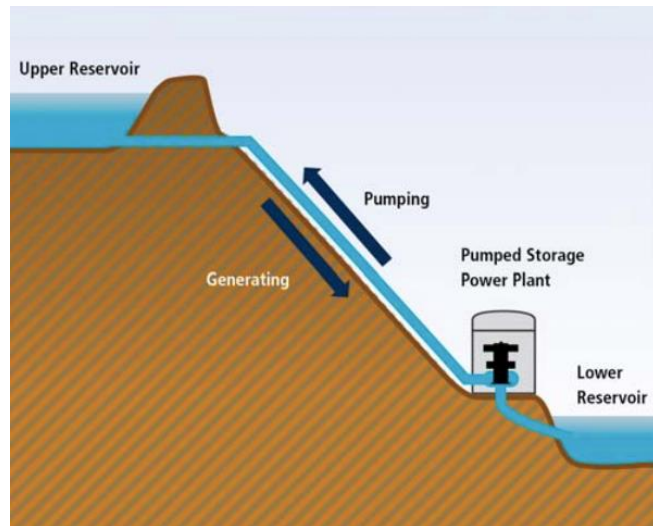

Figure 35. Typical pumped storage project.

8.1.4 In-stream technology using existing facilities

To optimize existing facilities like weirs, barrages, canals or falls, small turbines or hydrokinetic turbines can be installed for electricity generation. These basically function like a run-of-river scheme, as shown in Figure 36. Hydrokinetic devices being developed to capture energy from tides and currents may also be deployed inland in both free-flowing rivers and in engineered waterways.

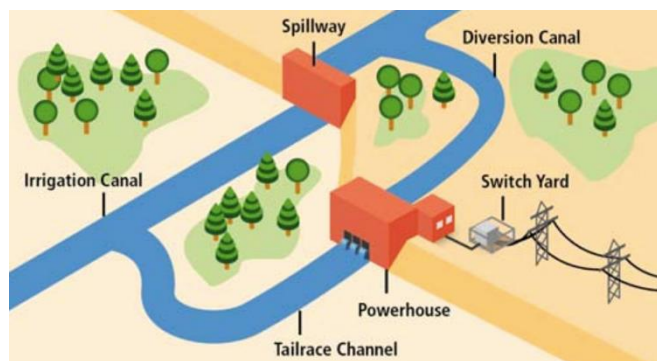

Figure 36. Typical in-stream hydropower plant using existing facilities.

8.2 Efficiency

The potential for energy production in a hydropower plant is determined by the following parameters, which are dependent on the hydrology, topography and design of the power plant:

- The amount of water available;
- Water loss due to flood spill, bypass requirements or leakage;
- The difference in head between upstream intake and downstream outlet;
- Hydraulic losses in water transport due to friction and velocity change; and
- The efficiency in energy conversion of electromechanical equipment.

The total amount of water available at the intake will usually not be possible to utilize in the turbines because some of the water will be lost or will not be withdrawn. This loss occurs because of water spill during high flows when inflow exceeds the turbine capacity, because of bypass releases for environmental flows, and because of leakage. In the hydropower plant the potential (gravitational) energy in water is transformed into kinetic energy and then mechanical energy in the turbine and further to electrical energy in the generator. The energy transformation process in modern hydropower plants is highly efficient, usually with well over 90% mechanical efficiency in turbines and over 99% in the generator. The inefficiency is due to hydraulic loss in the water circuit (intake, turbine and tailrace), mechanical loss in the turbo-generator group and electrical loss in the generator. Old turbines can have lower efficiency, and efficiency can also be reduced due to wear and abrasion caused by sediments in the water. The rest of the potential energy is lost as heat in the water and in the generator. In addition, some energy losses occur in the headrace section where water flows from the intake to the turbines, and in the tailrace section taking water from the turbine back to the river downstream. These losses, called head loss, reduce the head and hence the energy potential for the power plant. These losses can be classified either as friction losses or singular losses. Friction losses depend mainly on water velocity and the roughness in tunnels, pipelines and penstocks. The total efficiency of a hydropower plant is determined by the sum of these three loss components. Hydraulic losses can be reduced by increasing the turbine capacity or by increasing the reservoir capacity to get better regulation of the flow. Head losses can be

reduced by increasing the area of headrace and tailrace, by decreasing the roughness in these and by avoiding too many changes in flow velocity and direction. The efficiency of electromechanical equipment, especially turbines, can be improved by better design and also by selecting a turbine type with an efficiency profile that is best adapted to the duration curve of the inflow. Different turbine types have quite different efficiency profiles when the turbine discharge deviates from the optimal value (fig. 9).

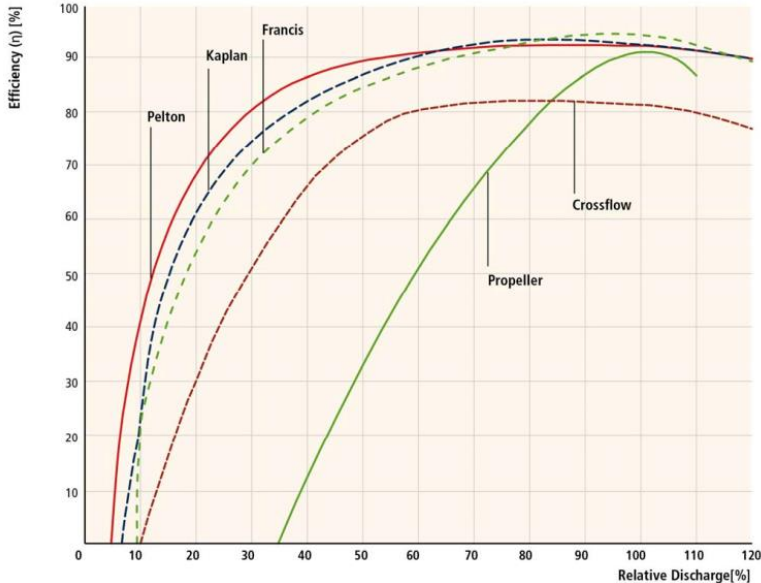

Figure 37. Typical efficiency curves for different types of hydropower turbines.

Chapter 9 Waste to energy

Wet waste, solid waste, and gaseous waste streams are potential high-impact resources for the domestic production of biofuels, bioproduct precursors, heat, and electricity. Wastes represent a significant and underutilized set of feedstocks for renewable fuel and product generation.

The following are classified as waste streams:

- Commercial, institutional, and residential food wastes, particularly those currently disposed of in landfills
- Biosolids, organic-rich aqueous streams, and sludges from municipal wastewater-treatment processes
- Manure slurries from concentrated livestock operations
- Organic wastes from industrial operations, including but not limited to food and beverage manufacturing, biodiesel production, and integrated biorefineries, as well as other industries such as pulp and paper, forest products, and pharmaceuticals
- Biogas derived from any of the above feedstock streams, including but not limited to landfill gas.

9.1 Technologies for conversion of biomass of energy

9.1.1 Incineration

Incineration is the process of direct controlled burning of waste in the presence of oxygen at temperatures of about 800°C and above, liberating heat energy, gases and inert ash. Net energy yield depends upon the density and composition of the waste. Relative percentage of moisture and inert materials, which add to the heat loss; ignition temperature; size and shape of the constituents; design of the combustion system, etc. In practice, about 65 to 80% of the energy content of the organic matter can be recovered as heat energy, which can be utilised either for direct thermal applications, or for producing power with the help of steam turbine-generators. The combustion temperature of conventional incinerators fuelled only by wastes are about 760°C in the furnace and in excess of 870°C in the secondary

combustion chamber. These temperatures are needed to avoid odour due to incomplete combustion but are insufficient to burn or even melt some of the inorganic contents such as glass. To avoid the deficiencies of conventional incinerators, some modern incinerators utilise higher temperature of up to 1650°C using auxiliary fuel. These reduce waste volume by nearly 97% and convert some inorganic contents such as metal and glass to inert ash. Wastes burned solely for volume reduction may not need any supplementary fuel except for start-up. When the objective is steam production, auxiliary fuel may have to be used with the pulverized refuse, because of the variable energy content of the waste or in the event that the quantity of waste available is insufficient. While Incineration is extensively used as an important method of waste disposal, it is associated with some polluting discharges which are of environmental concern, although in varying degrees of severity. These can fortunately be effectively controlled by installing suitable pollution control devices and by suitable furnace construction and control of the combustion process.

The basic operational steps of a waste incineration plant may include the following:

- Reception of incoming waste
- Storage of waste and raw materials
- Pre-treatment of waste
- Loading of waste into the process
- Thermal treatment of the waste
- Energy recovery and conversion
- Flue-gas cleaning
- Flue-gas cleaning residue management
- Flue-gas discharge
- Emissions monitoring and control
- Wastewater control and treatment (e.g. from site drainage, flue-gas treatment, storage)
- Ash/bottom ash management and treatment (arising from the combustion stage)

- Solid residue discharge/disposal.

There are many options for MSW incineration plant technology. The range of equipment varies from experimental to well-proven, though only the well-proven are recommended. Development problems with new technology are complicated and costly to solve, as developing countries lack the internal technical expertise to overcome them. Such problems could cause the entire project to fail. Based on the intended application, incineration plant equipment may be grouped in four main categories:

- A. Pre-treatment
- B. Combustion system
- C. Energy recovery
- D. Flue gas cleaning

Energy Recovery

Energy recovered from waste can be used in the following ways:

- A. Generation of Power (electricity),
- B. Generation of Heat,
- C. Generation of Heat and Power (CHP).

The energy generation option selected for an incineration facility will depend on the potential for end users to utilise the heat and/or power available. In most instances power can be easily distributed and sold via the national grid and this is by far the most common form of energy recovery. For heat, the consumer needs to be local to the facility producing the heat and a dedicated distribution system (network) is required. Unless all of the available heat can be used the generating facility will not always be operating at its optimum efficiency. The use of CHP combines the generation of heat and power (electricity). This helps to increase the overall energy efficiency for a facility compared to generating power only. In addition, as power and heat demand vary a CHP plant can be designed to meet this variation and hence maintain optimum levels of efficiency. Incineration processes are designed to recover energy from the waste processed by generating

electricity and/or heat for use on site and export off site. Electricity generated from the biodegradable fraction of waste in an Incinerator with good quality heat and power can benefit from support under the Renewables Obligation and Renewable Heat Incentive scheme.

9.1.2 Gasification

Gasification is a technological process that can convert any carbonaceous (carbon-based) raw material such as coal into fuel gas, also known as synthesis gas (syngas for short). Gasification occurs in a gasifier, generally a high temperature/pressure vessel where oxygen (or air) and steam are directly contacted with the coal or other feed material causing a series of chemical reactions to occur that convert the feed to syngas and ash/slag (mineral residues).

The process

Gasification is a partial oxidation process (fig 37). The term partial oxidation is a relative term which simply means that less oxygen is used in gasification than would be required for combustion (i.e., burning or complete oxidation) of the same amount of fuel. Gasification typically uses only 25 to 40 percent of the theoretical oxidant (either pure oxygen or air) to generate enough heat to gasify the remaining unoxidized fuel, producing syngas. The major combustible products of gasification are carbon monoxide (CO) and hydrogen (H₂), with only a minor amount of the carbon completely oxidized to carbon dioxide (CO₂) and water. The heat released by partial oxidation provides most of the energy needed to break up the chemical bonds in the feedstock, to drive the other endothermic gasification reactions, and to increase the temperature of the final gasification products.

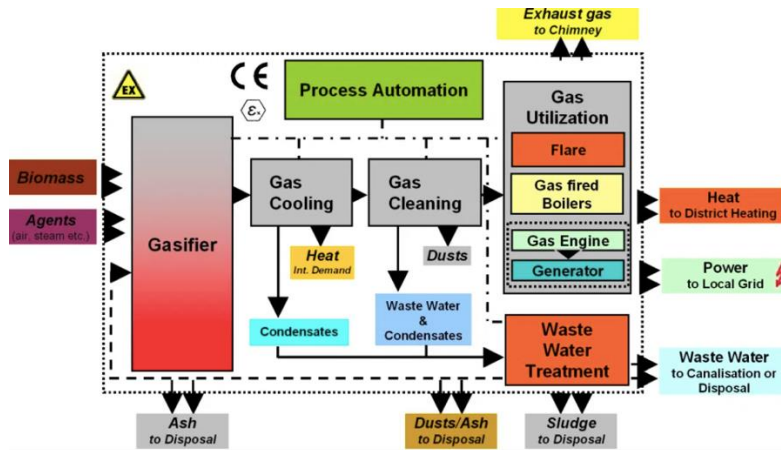

Figure38. Layout of a Typical Biomass Gasification Plant.

The products of gasification are a mixture of carbon monoxide, carbon dioxide, methane, hydrogen and various hydrocarbons, which can then be used directly in gas turbines, and boilers, or used as precursors for synthesising a wide range of other chemicals. In addition, there are a number of methods that can be used to produce higher quality product gases, including indirect heating, oxygen blowing, and pressurisation. After appropriate treatment, the resulting gases can be burned directly for cooking or heat supply, or used in secondary conversion devices, such as internal combustion engines or gas turbines, for producing electricity or shaft power (where it also has the potential for CHP applications).

The chemistry of gasification is quite complex and is accomplished through a series of physical transformations and chemical reactions within the gasifier (fig 39). Some of the major chemical reactions are shown in the diagram below. In a gasifier, the carbonaceous feedstock undergoes several different processes and/or reactions:

- **Dehydration** – Any free water content of the feedstock evaporates, leaving dry material and evolving water vapor which may enter into later chemical reactions.
- **Pyrolysis** – This occurs as the feedstock is exposed to rising temperature in the gasifier. Devolatilization and breaking of the weaker chemical bonds occurs,

releasing volatile gases such as tar vapours, methane, and hydrogen, along with producing a high molecular weight char which will undergo gasification reactions.

- **Combustion** – The volatile products and some of the char react with limited oxygen to form carbon dioxide (CO₂), carbon monoxide (CO), and in doing so, provide the heat needed for subsequent gasification reactions.
- **Gasification** – The remaining char reacts with CO₂ and steam to produce CO and hydrogen (H₂).
- **Water-gas-shift and methanation** – These are separate reversible gas phase reactions taking place simultaneously based on gasifier conditions. These are minor reactions which play a small role within in the gasifier. Depending on the desired product, the syngas may undergo further water-gas shift and methanation processing downstream from the gasifiers.

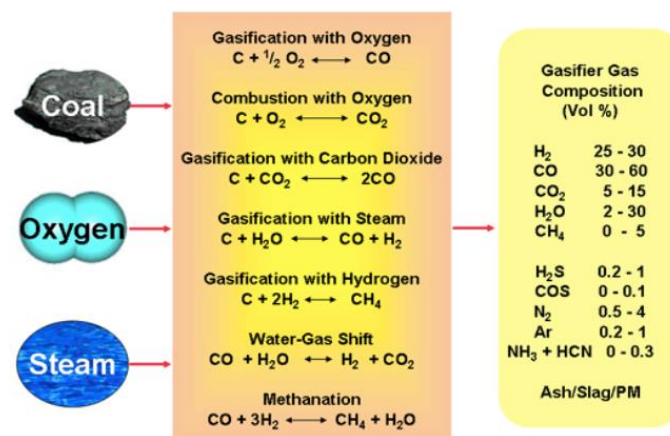

Figure39. Reactions & transformations in Gasification.

9.1.3 Pyrolysis

Pyrolysis is a thermochemical treatment, which can be applied to any organic (carbon-based) product. It can be done on pure products as well as mixtures. In this treatment, material is exposed to high temperature, **and** in the absence of oxygen goes through chemical and physical separation into different molecules. The decomposition takes place thanks to the limited thermal stability of chemical bonds of materials, which allows them to be disintegrated by using the heat.

Thermal decomposition leads to the formation of new molecules. This allows to receive products with a different, often more superior character than original residue. Thanks to this feature, pyrolysis becomes increasingly important process for today industry – as it allows to bring far greater value to common materials and waste.

Pyrolysis is frequently associated with thermal treatment (fig 40). But in contrary to combustion and gasifications processes, which involve entire or partial oxidation of material, pyrolysis bases on heating in the absence of air. This makes it mostly endothermic process that ensure high energy content in the products received. Pyrolysis products always produce solid (charcoal, biochar), liquid and non-condensable gases (H_2 , CH_4 , C_nH_m , CO , CO_2 and N). As the liquid phase is extracted from pyrolysis gas only during it's cooling down, in some applications, these two streams can be used together when providing hot syngas directly to the burner or oxidation chamber (see « Directions of hot syngas utilisation»). During the pyrolysis, a particle of material is heated up from the ambient to defined temperature (setup temperature of Biogreen equipment). The material remains inside the pyrolysis unit and is transported by screw conveyor at defined speed, until the completion of the process. Chosen temperature of pyrolysis defines the composition and yields of products (pyrolysis oil, syngas and char).

Basic principal of pyrolysis

The thermal decomposition process of pyrolysis using lignocellulosic biomass takes place in the absence of oxygen under inert atmosphere. As an inert atmosphere argon or nitrogen gas flow is usually needed. The fundamental chemical reaction is very complex and consists of several steps. The end products of biomass pyrolysis consist of biochar, bio-oil and gases. Pyrolysis process emits mainly methane, hydrogen, carbon monoxide and carbon dioxide. The organic materials present in the biomass substrate starts to decompose around 350–550°C and it can proceed until 700–800°C without the presence of air/oxygen. Biomass is mainly composed of long polymeric chain of cellulose, lignin, hemicellulose, pectin and others. The larger molecules of organic materials start to decompose to yield smaller molecules, which are released from the process stream as gases, condensable vapours (tars

and oils) and solid char during pyrolysis process. The proportion of each end product depends on the temperature, time, heating rate, and pressure, types of precursors and reactor design and configuration. Figure 3 illustrates the decomposition process of main lignocellulosic residues at different temperature. The moisture content of biomass also plays a vital role in pyrolysis processes. The moisture content of the feedstock should be around 10% during fast pyrolysis process.

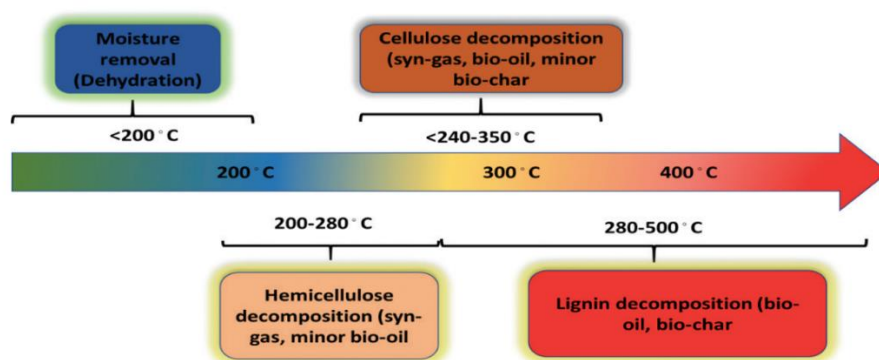

Figure 40. Decomposition behaviour of biomass constituents at different temperature.

Due to high moisture content, major products become liquids and if there is low level of water, there is high risk that the process produces huge amount of dust instead of oil. Thus, sludge derived from waste stream and meat-processing wastes require drying before exposing them finally to pyrolysis environment. Less than 450°C when the heating rate is slow, the main yield is biochar. However, at higher temperature that is more than 800°C when the heating rate is high then larger fraction of ash and gaseous products are produced. Bio-oil can be produced applying intermediate temperature using relatively high heating rates. During the beginning of the process around temperature 250–300°C, volatile materials are released at almost 10 times quicker than the subsequent step. Woody biomass was initially used to produce charcoal. The charcoal based on wood during heating produces negligible amount of smoke. Earlier it was extensively used for melting of ore to extract iron. However, the process had drawbacks of less yield percentages, less energy and excessive air pollution. After that, modern technology

was developed to extract maximum possible energy from biomass using combustion (exothermic), gasification (exothermic) and pyrolysis (endothermic). Combustion deals with the burning of biomass in presence of oxygen to produce heat. The competence of this practice is not satisfactory. Gasification also takes place under oxygenated atmosphere which will yield gaseous fuels. Nevertheless, pyrolysis is the leading phase for both gasification and combustion processes. Consequently, pyrolysis can be considered as part of gasification and combustion. The decomposition products yield of biomass during pyrolysis is provided by following figure 41.

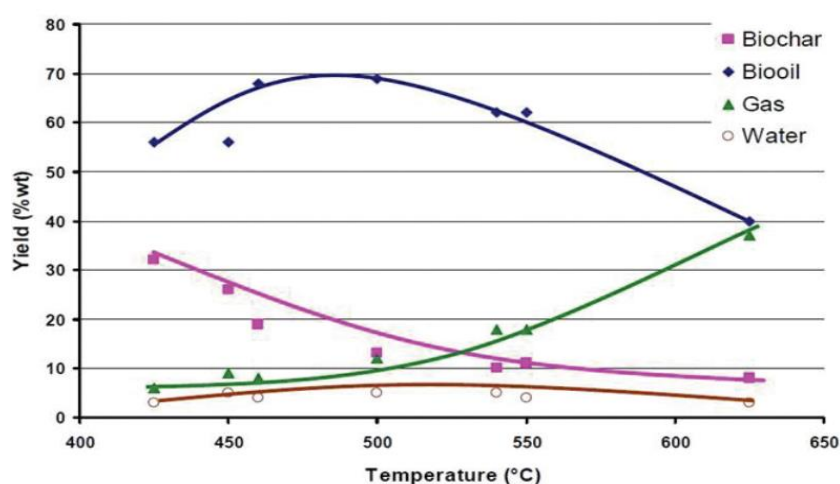

Figure 41. The decomposition products of pyrolysis of biomass.

9.1.4 Types of pyrolysis

Overall the pyrolysis process can be classified as slow and fast depending on the heating rate. In slow pyrolysis process, the time of heating the biomass substrate to pyrolysis temperature is longer than the time of retention of the substrate at characteristic pyrolysis reaction temperature. However, in fast pyrolysis, the initial heating time of the precursors is smaller than the final retention time at pyrolysis peak temperature. Based on medium, pyrolysis can be of another two types namely hydrous pyrolysis and hydro pyrolysis. Slow and fast pyrolysis is

usually carried out in inert atmosphere whereas hydrous pyrolysis is carried out in presence of water and hydro-pyrolysis is carried out in presence of hydrogen. The residence time of vapour in the pyrolysis medium is longer for slow pyrolysis process. This process is mainly used to produce char production. It can be further classified as Carbonization and Conventional. On the contrary, the vapour residence time is only for seconds or milliseconds. Table 1 summarizes some basic characteristics of different types of pyrolysis process.

Table 1. Different types of pyrolysis process.

Pyrolysis types	Retention time	Rate of heating	Final temperature (°C)	Products
Fast	<2 s	Very high	500	Bio-oil
Flash	<1 s	High	<650	Bio-oil, chemicals and gas
Ultra-rapid	<0.5 s	Very high	1000	Chemical and gas
Vacuum	2–30 s	Medium	400	Bio-oil
Hydro-pyrolysis	<10 s	High	<500	Bio-oil
Carbonization	days	Very low	400	Charcoal
Conventional	5–30 min	Low	600	Char, bio-oil and gas

Fast pyrolysis

During the fast pyrolysis process, biomass residues are heated in absence of oxygen at high temperature using higher heating rate. Based on the initial weight of the biomass, fast pyrolysis can provide 60–75% of liquid biofuels with 15–25% of biochar residues. It can also yield 10–20% of gaseous phase depending on the biomass used. The process is characterized by small vapour retention time. However, quick chilling of vapours and aerosol can ensure higher bio-oil yield. It can provide liquid biofuel for turbine, boiler, engine, power supplies for industrial applications. Fast pyrolysis technology is getting implausible acceptance for producing liquid fuels due to certain technical advantages:

1. It can ensure preliminary disintegration of the simple oligomer and lignin portions from lignocellulosic biomass with successive upgrading.
2. The scaling up of this process is economically feasible.
3. It can utilize second generation bio-oil feed stocks such as forest residues, municipal and industrial wastes.
4. It provides easy storability and transportability of liquid fuels.
5. It can ensure secondary transformation of motor fuels, additives or special chemicals.

Flash pyrolysis

The flash pyrolysis process of biomass can give solid, liquid and gaseous products. The bio-oil production can go up to 75% using flash pyrolysis. This procedure is carried out by speedy devolatilization under inert atmosphere using higher heating rate with high pyrolysis temperatures around 450 and 1000°C. In this process, the gas residence time (less than 1 s) is too little. Nevertheless, this process has poor thermal stability. Due to catalytic effect of the char, the oil becomes viscous and sometimes it contains some solid residues also.

Slow pyrolysis

Slow pyrolysis can yield good quality charcoal using low temperature and low heating rates. The vapour residence time can be around 5–30 min in this process. The volatile organic fractions present in vapour phase continue to react with each other to yield char and some liquid fractions. The quality of bio-oil produce in this process is very low. Longer residence time initiates further cracking to reduce the yield of bio-oil. The process suffers from low heat transfer values with longer retention time leading to enhance the expenditure by higher input of energy. The stoichiometric equation for production of charcoal is shown by following equation:

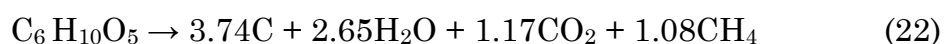

9.1.5 Anaerobic Digestion

The process

Anaerobic digestion is a biological process which converts the organic biomass to the mixture of combustible gases in absence of oxygen. Biogas plant can be fed with animal waste/slurries, crop/animal feed residues or purposely grown crops such as maize with the energy value of each feedstock being different. A biogas plant can convert animal manure, green plants, waste from Argo industry and slaughterhouses into biogas. Biogas produced from the waste consists of 50-70 % methane, 25-40% carbon dioxide and 2-8% of water vapours and traces of O_2N_2 , NH_3 , H_2S . Source of biomass can be agricultural waste, animal waste, municipal waste etc. Biogas can be used for various heating and power generation purposes. As Biogas is composition of various gases so, it cannot be directly used for internal combustion engine. For this purpose, it needs to be upgraded which refers to removal of carbon dioxide and other impurities.

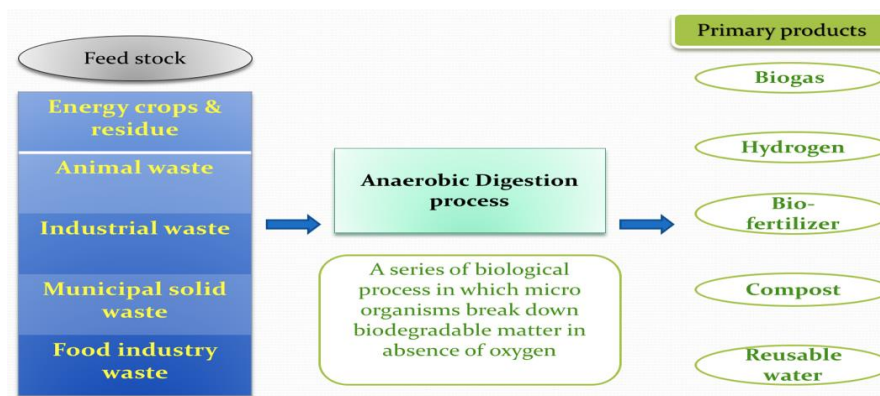

Figure 12. Biogas production process by anaerobic digestion.

The volumetric biogas potential of an biogas plant is a major economic metric as biogas generation determines the ratio of production of saleable energy and the capital invested in the volumetric capacity of the plant[9]. Therefore, AD system design should ideally support high biogas yields whilst maximizing OLR in the shortest HRT[10]. Overall efficiency of a biogas plant can be calculated in terms of biogas yields and the power consumption by plant itself. Biogas yield depends on various factors like substrate type, temperature, pH, HRT, OLR and mixing whereas the energy consumption by biogas plant is due to feeding systems, mixing

of slurry and transportation of substrate within the plant. So, the design of biogas plant must be optimized to decrease the capital costs of installation as well as associated mixing energy and costs.

Before studying effect of mixing on biogas production it is very important to understand the anaerobic digestion process. The AD of organic material basically involves following steps; hydrolysis, acidogenesis, acetogenesis and methanogenesis as shown in Fig. 2. The biological aspects of AD are dealt with in specialised literature[11]. AD is a complex process which requires strict anaerobic conditions $ORP < -200$ mV to proceed and depends on the coordinated activity of a complex microbial association to transform organic material into mostly CO_2 and methane (CH_4). Despite the successive steps, hydrolysis is generally considered as rate limiting[12]. The hydrolysis step degrades both insoluble organic material and high molecular weight compounds such as lipids, polysaccharides, proteins and nucleic acids, into soluble organic substances (e.g. amino acids and fatty acids). The components formed during hydrolysis are further split during acidogenesis, the second step. VFA are produced by acidogenic (or fermentative) bacteria along with ammonia (NH_3), CO_2 , H_2S and other by-products. The third stage in AD is acetogenesis, where the higher organic acids and alcohols produced by acidogenesis are further digested by acetogens to produce mainly acetic acid as well as CO_2 and H_2 . This conversion is controlled to a large extent by the partial pressure of H_2 in the mixture.

Hydrolysis

Hydrolysis is the initial step of decomposition. during which the complex organic matter (polymers) is decomposed into smaller units (mono- and oligomers). During hydrolysis, polymers like carbohydrates, lipids, nucleic acids and proteins are converted into glucose, glycerol, purines and pyridines. Hydrolytic microorganisms excrete hydrolytic enzymes, converting biopolymers into simpler and soluble compounds as it is shown below:

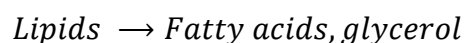

Polysaccharide → Monosaccharide

Protiens → Amino acids

Acidogenesis

During acidogenesis, the products of hydrolysis are converted by acidogenic (fermentative) bacteria into methanogenic substrates. Simple sugars, amino acids and fatty acids are degraded into acetate, carbon dioxide and hydrogen (70%) as well as into volatile fatty acids (VFA) and alcohols (30%).

Amino acids, fatty acids, sugars → Long chain fatty acids

Acetogenesis

Products from acidogenesis, which cannot be directly converted to methane by methanogenic bacteria, are converted into methanogenic substrates during acetogenesis. VFA and alcohols are oxidised into methanogenic substrates like acetate, hydrogen and carbon dioxide. VFA, with carbon chains longer than two units and alcohols, with carbon chains longer than one unit, are oxidized into acetate and hydrogen. The production of hydrogen increases the hydrogen partial pressure. This can be regarded as a „waste product “of acetogenesis and inhibits the metabolism of the acetogenic bacteria. During methanogenesis, hydrogen is converted into methane. Acetogenesis and methanogenesis usually run parallel, as symbiosis of two groups of organisms.

Methanogenesis

The final stage of methanogenesis produces methane by two groups of methanogenic bacteria: the first group splits acetate into methane and carbon dioxide and the second group uses hydrogen as electron donor and carbon dioxide as acceptor to produce methane.

Methanogenesis is a critical step in the entire anaerobic digestion process, as it is the slowest biochemical reaction of the process. Methanogenesis is severely influenced by operation conditions. Composition of feedstock, feeding rate,

temperature, and pH are examples of factors influencing the methanogenesis process. Digester overloading, temperature changes or large entry of oxygen can result in termination of methane production.

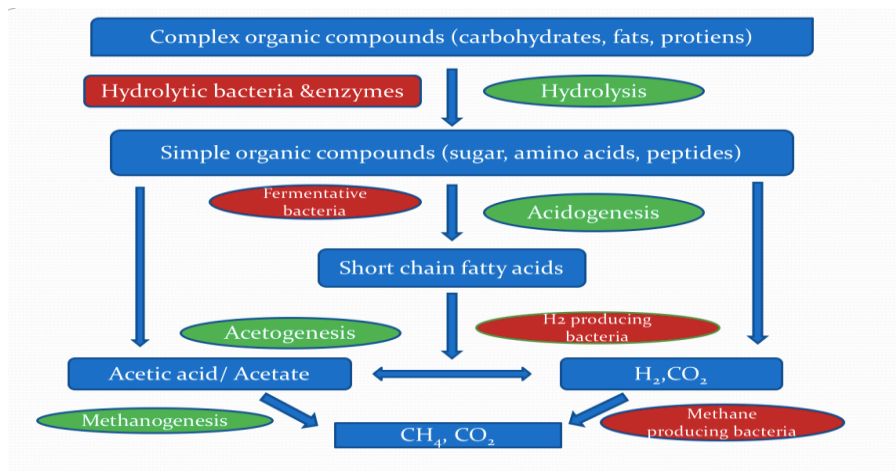
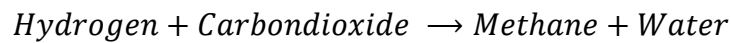
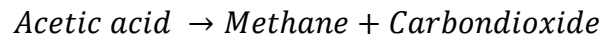

Figure 43. Subsequent steps in anaerobic digestion process.

Different types of biogas plants

- **Fixed dome type**

A fixed-dome plant consists of a digester with a fixed, non-movable gas holder, which sits on top of the digester. When gas production starts, the slurry is displaced into the compensation tank. Gas pressure increases with the volume of gas stored and the height difference between the slurry level in the digester and the slurry level in the compensation tank. The costs of a fixed-dome biogas plant are relatively low. It is simple as no moving parts exist. There are also no rusting steel parts and hence a long life of the plant (20 years or more) can be expected. The plant is constructed underground, protecting it from physical damage and

saving space. While the underground digester is protected from low temperatures at night and during cold seasons, sunshine and warm seasons take longer to heat up the digester. No day/night fluctuations of temperature in the digester positively influence the bacteriological processes. The construction of fixed dome plants is labour-intensive, thus creating local employment. Fixed-dome plants are not easy to build. They should only be built where construction can be supervised by experienced biogas technicians. Otherwise plants may not be gas-tight (porosity and cracks).

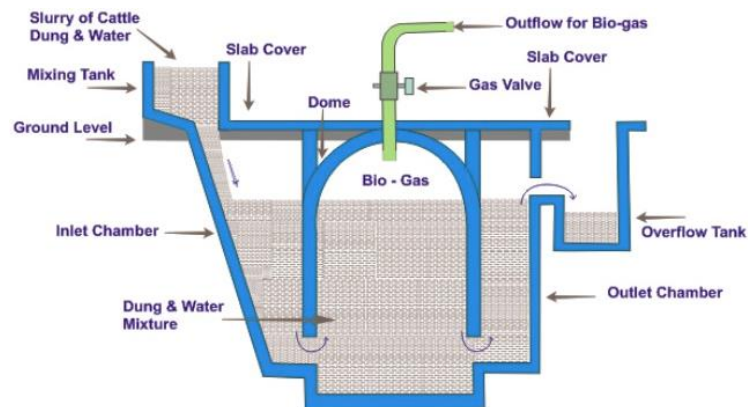

Figure 44. Fixed dome type biogas plant.

- **Floating drum biogas plant**

Floating-drum plants consist of an underground digester (cylindrical or dome-shaped) and a moving gas-holder. The gas-holder floats either directly on the fermentation slurry or in a water jacket of its own. The gas is collected in the gas drum, which rises or moves down, according to the amount of gas stored. The gas drum is prevented from tilting by a guiding frame. When biogas is produced, the drum moves up when it is consumed, the drum goes down. If the drum floats in a water jacket, it cannot get stuck, even in substrate with high solid content. After the introduction of cheap Fixed-dome Chinese model, the floating drum plants became obsolete as they have high investment and maintenance cost along with other design weakness

Material of digester and drum

The digester is usually made of brick, concrete or quarry-stone masonry with plaster. The gas drum normally consists of 2.5 mm steel sheets for the sides and 2 mm sheets for the top. It has welded-in braces which break up surface scum when the drum rotates. The drum must be protected against corrosion. Suitable coating products are oil paints, synthetic paints and bitumen paints. Correct priming is important. There must be at least two preliminary coats and one topcoat. Coatings of used oil are cheap. They must be renewed monthly. Plastic sheeting stuck to bitumen sealant has not given good results. In coastal regions, repainting is necessary at least once a year, and in dry uplands at least every other year. Gas production will be higher if the drum is painted black or red rather than blue or white, because the digester temperature is increased by solar radiation. Gas drums made of 2 cm wire-mesh-reinforced concrete or fiber-cement must receive a gas-tight internal coating. The gas drum should have a slightly sloping roof, otherwise rainwater will be trapped on it, leading to rust damage. An excessively steep-pitched roof is unnecessarily expensive and the gas in the tip cannot be used because when the drum is resting on the bottom, the gas is no longer under pressure. Floating-drums made of glass-fiber reinforced plastic and high-density polyethylene have been used successfully, but the construction costs are higher compared to using steel. Floating-drums made of wire-mesh-reinforced concrete are liable to hairline cracking and are intrinsically porous. They require a gas-tight, elastic internal coating. PVC drums are unsuitable because they are not resistant to UV.

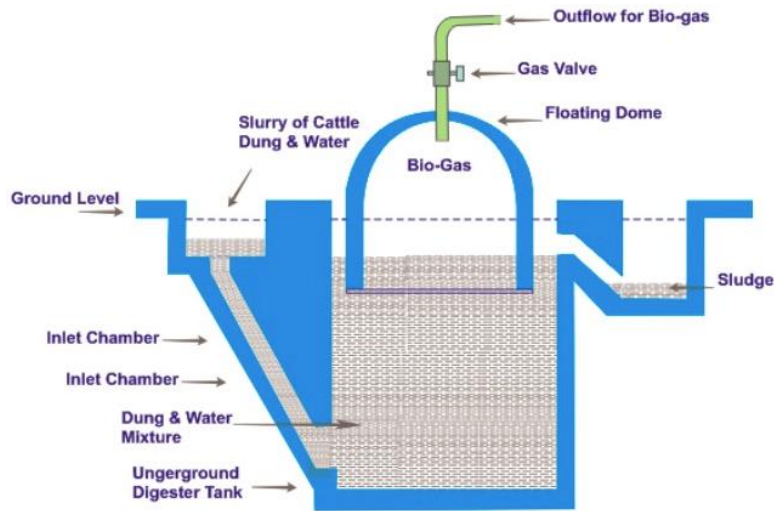

Figure 45. Floating dome type biogas plant.

The side wall of the gas drum should be just as high as the wall above the support ledge. The floating drum must not touch the outer walls. It must not tilt, otherwise the coating will be damaged, or it will get stuck. For this reason, a floating drum always requires a guide. This guide frame must be designed in a way that allows the gas drum to be removed for repair. The drum can only be removed if air can flow into it, either by opening the gas outlet or by emptying the water jacket. The floating gas drum can be replaced by a balloon above the digester. This reduces construction costs but in practice problems always arise with the attachment of the balloon to the digester and with the high susceptibility to physical damage.

Types of floating drum biogas plant:

- **KVIC model** with a cylindrical digester, the oldest and most widespread floating drum biogas plant from India.
- **Pragati model** with a hemisphere digester
- **Ganesh model** made of angular steel and plastic foil
- floating-drum plant made of prefabricated reinforced concrete compound units
- floating-drum plant made of fibre-glass reinforced polyester

- low cost floating-drum plants made of plastic water containers or fiberglass drums: ARTI Biogas plants
- **BORDA model:** The BORDA-plant combines the static advantages of hemispherical digester with the process-stability of the floating-drum and the longer life span of a water jacket plant.

- **Low cost polyethene tube digester**

In the case of the Low-Cost Polyethylene Tube Digester model which is applied in Bolivia (Peru, Ecuador, Colombia, Centro America and Mexico), the tubular polyethylene film (two coats of 300 microns) is bended at each end around a 6 inch PVC drainpipe and is wound with rubber strap of recycled tire-tubes. One of the 6" PVC drainpipes serves as inlet and the other one as the outlet of the slurry. In the tube digester finally, a hydraulic level is set up by itself, so that as much quantity of added prime matter (the mix of dung and water) as quantity of fertilizer leave by the outlet. Because the tubular polyethylene is flexible, it is necessary to construct a "cradle" which will accommodate the reaction tank, so that a trench is excavated

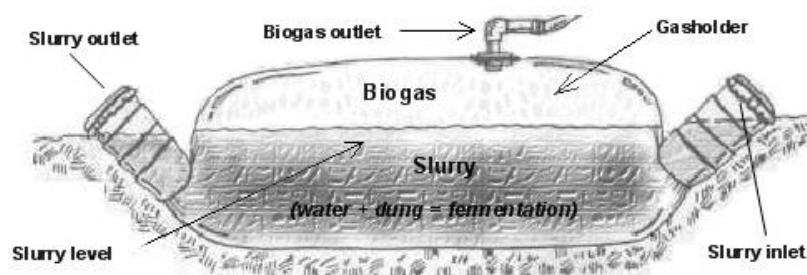

Figure 46. Low cost polyethene tube digester.

- **Balloon types biogas plant**

A balloon plant consists of a heat-sealed plastic or rubber bag (balloon), combining digester and gas-holder. The gas is stored in the upper part of the balloon. The inlet and outlet are attached directly to the skin of the balloon. Gas pressure can be increased by placing weights on the balloon. If the gas pressure exceeds a limit that the balloon can withstand, it may damage the skin. Therefore, safety valves

are required. If higher gas pressures are needed, a gas pump is required. Since the material has to be weather- and UV resistant, specially stabilized, reinforced plastic or synthetic caoutchouc is given preference. Other materials which have been used successfully include RMP (red mud plastic), Trevira and butyl. The useful life-span does usually not exceed 2-5 years.

Advantages:

- Standardized prefabrication at low cost,
- low construction sophistication,
- ease of transportation,
- shallow installation suitable for use in areas with a high groundwater table;
- high temperature digesters in warm climates;
- uncomplicated cleaning,
- emptying and maintenance;
- difficult substrates like water hyacinths can be used

Balloon biogas plants are recommended, if local repair is or can be made possible and the cost advantage is substantial.

Disadvantages:

- Low gas pressure may require gas pumps;
- scum cannot be removed during operation;
- the plastic balloon has a relatively short useful life-span and is susceptible to mechanical damage and usually not available locally. In addition, local craftsmen are rarely in a position to repair a damaged balloon. There is only little scope for the creation of local employment and, therefore, limited self-help potential.



Figure 47. Balloon types biogas plant.

Table 2. The table gives a broad comparison of the different types.

Factors	Fixed dome	Floating drum	Tubular design	Plastic containers
Gas storage	Internal Gas storage up to 20 m ³ (large)	Internal Gas storage drum size (small)	Internal eventually external plastic bags	Internal Gas storage drum sizes (small)
Gas pressure	Between 60 and 120 mbar	Upto 20 mbar	Low, around 2 mbar	Low around 2mbar
Skills of contractor	High; masonry, plumbing	High; masonry, plumbing, welding	Medium; plumbing	Low; plumbing
Availability of Material	yes	yes	yes	yes
Durability	Very high >20 years	High; drum is weakness	Medium; Depending on chosen liner	Medium
Agitation	Self agitated by Biogas pressure	Manual steering	Not possible; plug flow type	Evtl Manual steering
Sizing	6 to 124 m ³ digester vol	Up to 20 m ³	Combination possible	Up to 6 m ³ digester vol
Methane emission	High	Medium	Low	Medium

Reference:

- [1] T. Kober, H. W. Schiffer, M. Densing, and E. Panos, "Global energy perspectives to 2060 – WEC's World Energy Scenarios 2019," *Energy Strateg. Rev.*, vol. 31, no. December 2019, p. 100523, 2020, doi: 10.1016/j.esr.2020.100523.
- [2] Shobh Nath Singh, *Non conventional Energy Sources*. Pearson India Education Services Pvt. Ltd.,
- [3] B. H. Khan, *Non-Conventional Energy Resources Third Edition About the Author*, Third. McGraw Hill Education (India) Private Limited.
- [4] D. Chiras, *WIND POWER Basics*, First. Canada: New Society Publishers, 2010.
- [5] A. Ramos-Escudero, M. S. García-Cascales, J. M. Cuevas, B. Sanner, and J. F. Urchueguía, "Spatial analysis of indicators affecting the exploitation of shallow geothermal energy at European scale," *Renew. Energy*, vol. 167, no. xxxx, pp. 266–281, 2021, doi: 10.1016/j.renene.2020.11.081.
- [6] U. S. E. I. Administration, "EIA Geothermal," 2019. [Online]. Available: <https://www.eia.gov/energyexplained/geothermal/use-of-geothermal-energy.php>.
- [7] Ricotti ME. Nuclear energy : basics , present , future 2013;01005.
- [8] Patterson WC. Nuclear power n.d.:1–191.
- [9] Banks, C.J. & Zhang Y. Optimising inputs and outputs from anaerobic digestion processes. Southampton: 2010.
- [10] Ward, A.J., Hobbs, P.J., Holliman, P.J. & Jones DL. Optimisation of the anaerobic digestion of agricultural resources. *Bioresour Technol* 2008;99:7928–7940.
- [11] Appels L, Baeyens J, Degrève J, Dewil R. Principles and potential of the anaerobic digestion of waste-activated sludge. *Prog Energy Combust Sci* 2008;34:755–81. doi:10.1016/j.pecs.2008.06.002.

- [12] Qasim BR. Wastewater Treatment Plants Planning, Design, and Operation. 1998.

Appendix

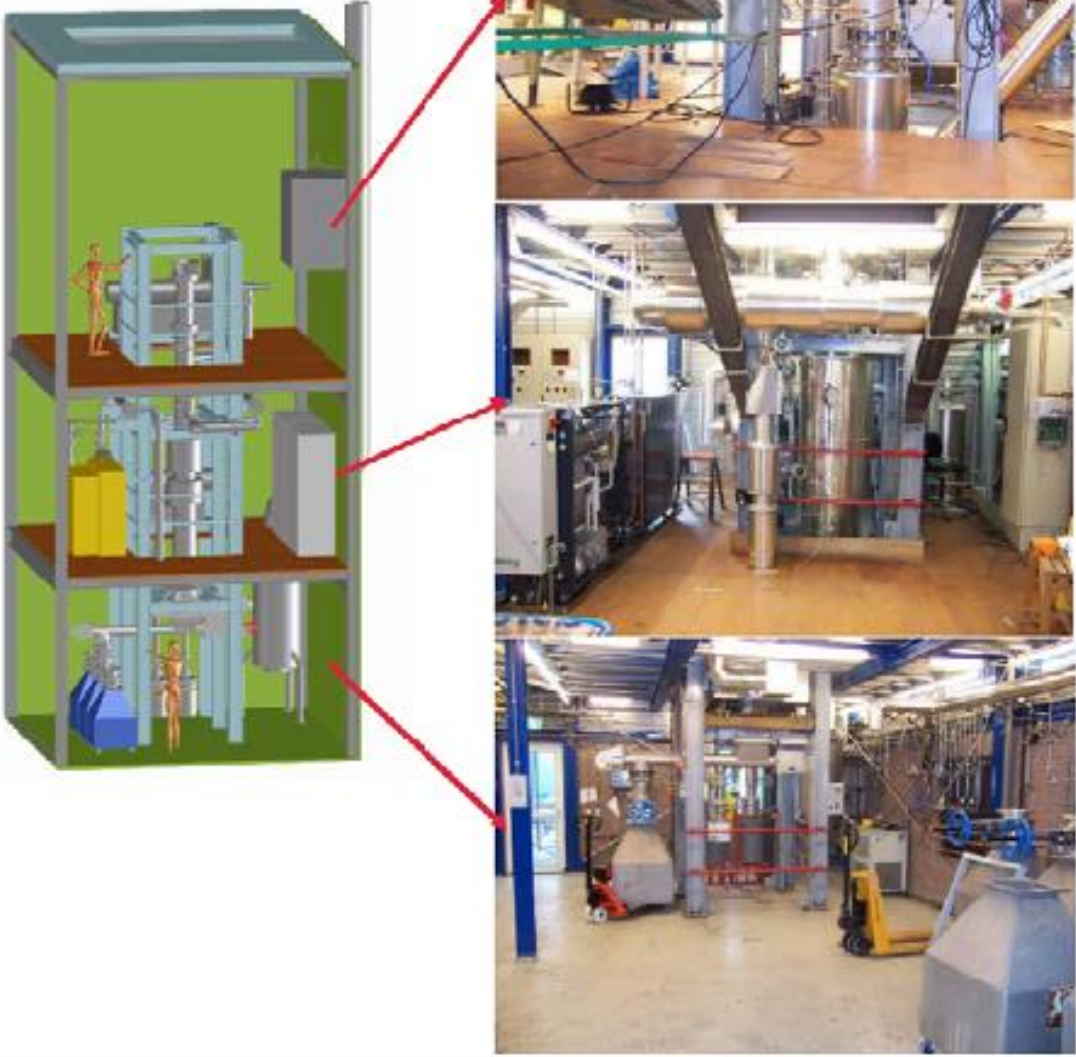



Biomass on feeding system



Fresh biomass



Fresh biomass



Torrefied biomass in full product collection vessel



Biomass sample



Torrefied biomass sample

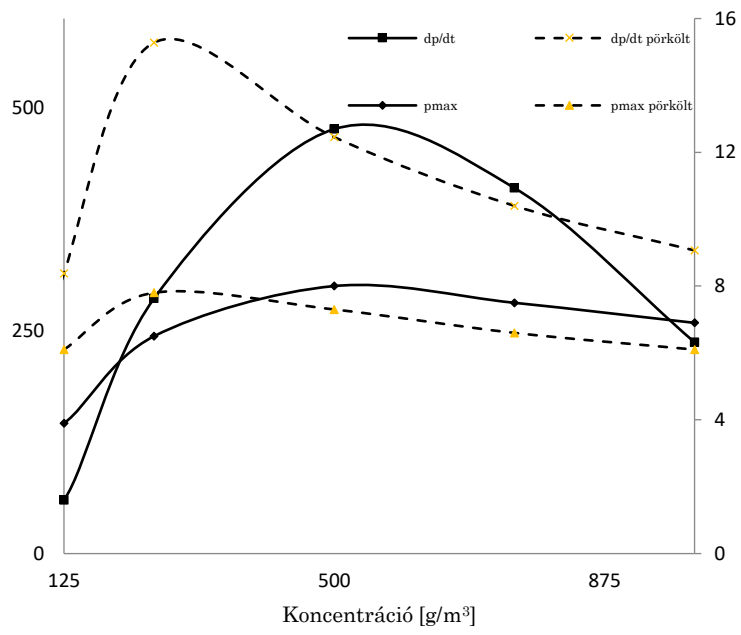
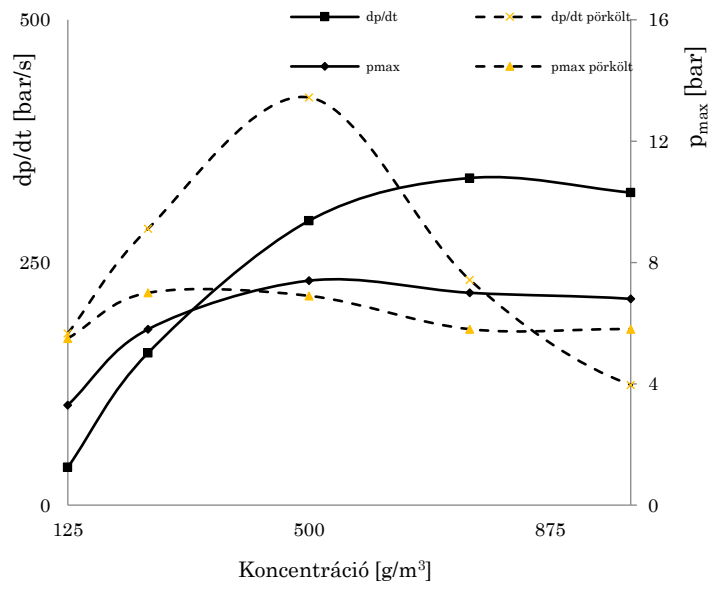

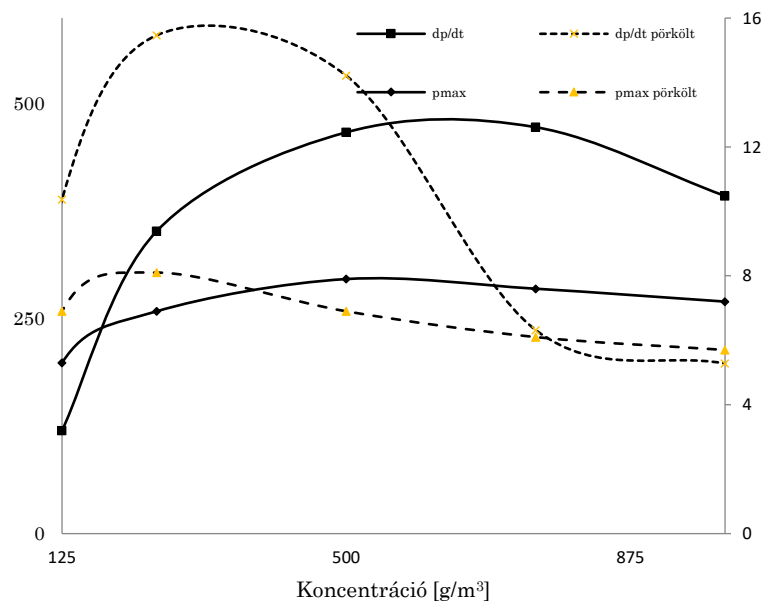

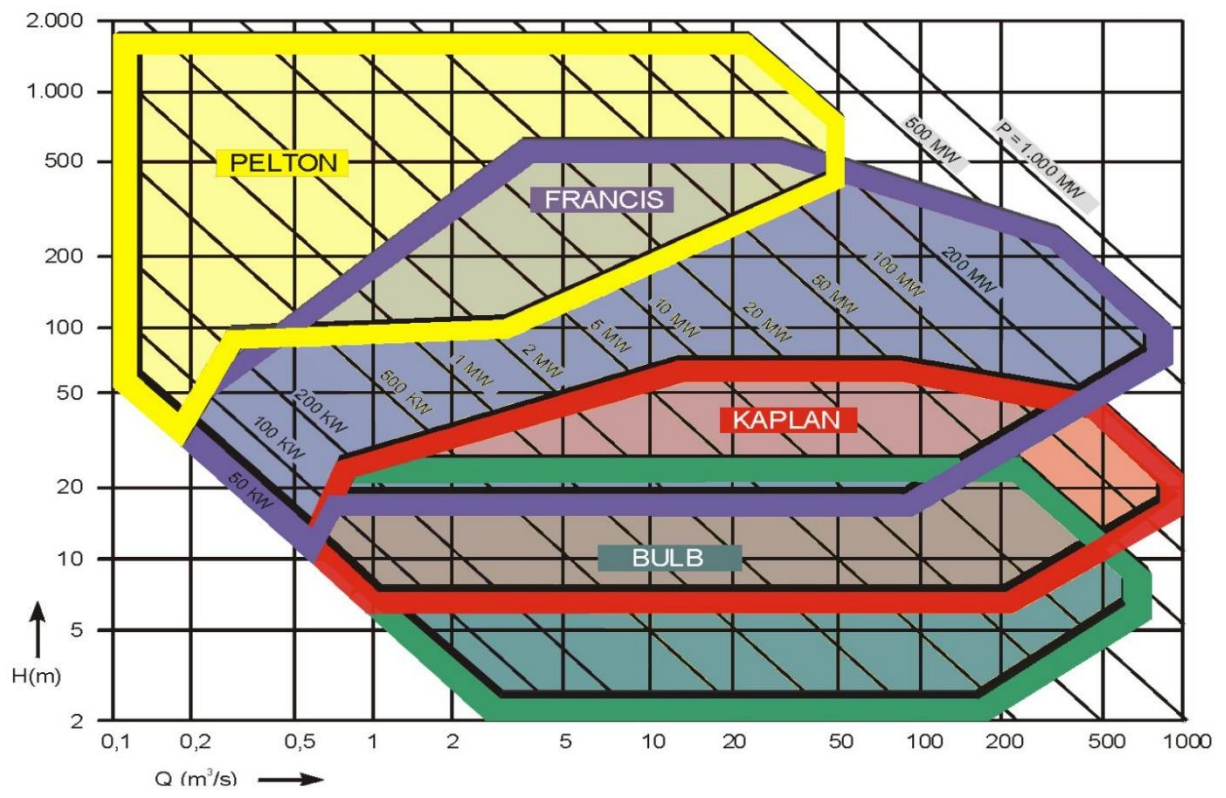

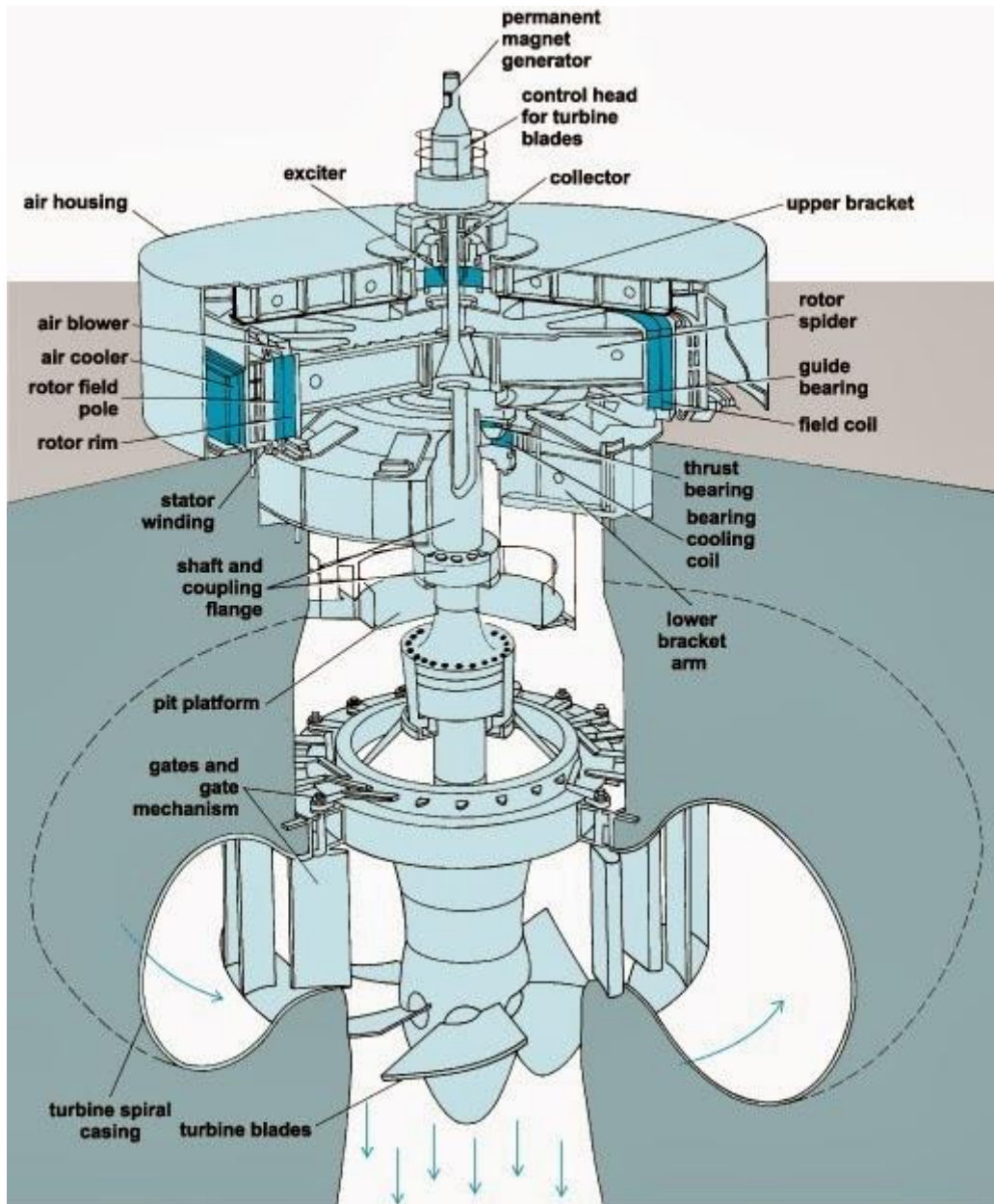

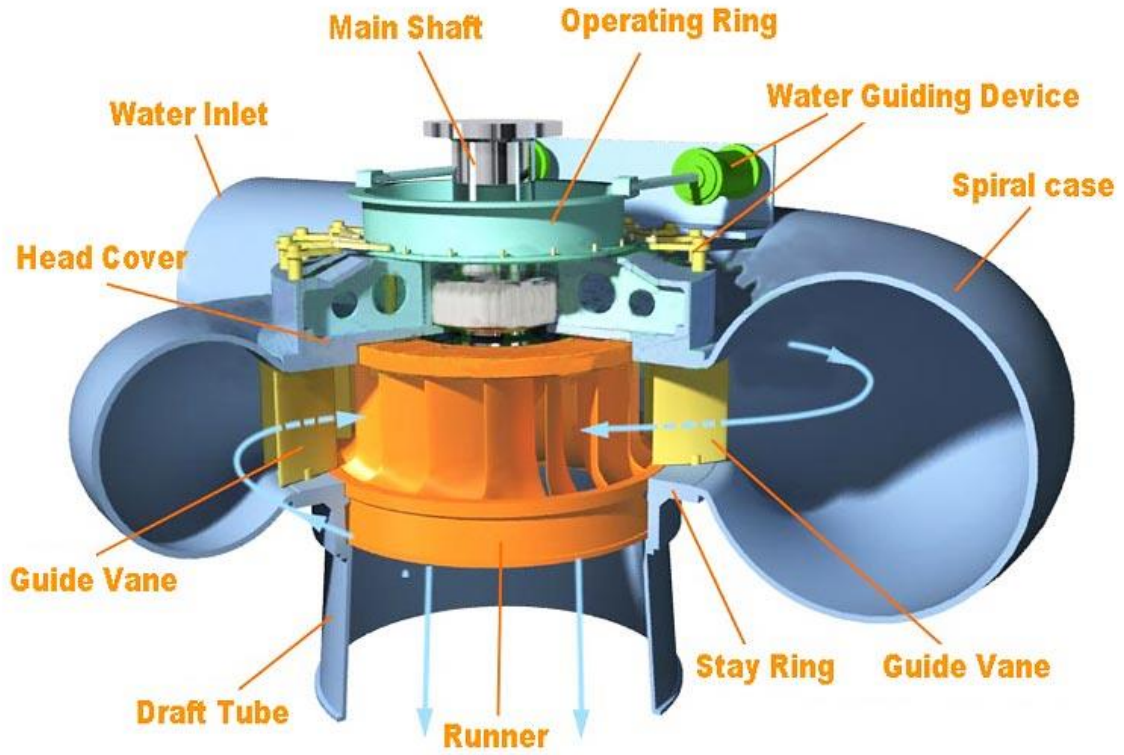

Francis Turbine



